

# TAPAS DE PLÁSTICO DE COMPRESIÓN COMPRESSION MOULDED CAPS BOUCHONS EN THERMODUR



AMPLIA GAMA DE TAPAS ESTÁNDARES ALTAMENTE PERSONALIZABLES Y POSIBILIDAD DE ESPECÍFICOS CON UNA INVERSIÓN EN MOLDES MUY ASEQUIBLE.

PACKAGING IDEAL PARA FORMULAS LÍQUIDAS, POLVOS, ... (TÓNICOS, ACEITES, PERFUMES, SOMBRA DE OJOS, ...)

PACKAGING PRÁCTICO, APLICACIÓN SPLASH, PARA PRODUCTO VENTA O MUESTRA. MATERIALES DE ALTA CALIDAD DE PESO CUALITATIVO.

POSIBILIDAD DE PACKS COMPLETOS CON NUESTRA GAMA DE FRASCOS DE TUBO.

LARGE RANGE OF STANDARD CAPS HIGHLY CUSTOMISABLE AND POSSIBILITY OF CUSTOM DESIGNS AT INEXPENSIVE TOOLING COST.

IDEAL FOR LIQUID SOLUTIONS, POWDERS, ... (TONERS, OILS, PERFUMES, LOOSE EYE SHADOW, ...)

PRACTICAL PACKAGING, SPLASH APPLICATION, FOR SALEABLE ITEMS OR SAMPLES. HIGH QUALITY MATERIALS OF CONSIDERABLE WEIGHT

POSSIBILITY OF COMPLETE PACKS WITH OUR TUBULAR GLASSVIALS

AMPLE GAMME DE CAPSULES STANDARDS HAUTEMENT PERSONNALISABLES ET POSSIBILITÉ DE SPÉCIFIQUES AVEC INVESTISSEMENT OUTILLAGES TRÈS ABORDABLE.

PACKAGING IDÉAL POUR FORMULES LIQUIDES, POUDRÉS, ... (TONIQUES, HUILES, PARFUMS, DISSOLVANTS, OMBRE À PAUPIÈRES, ...)

PACKAGING PRATIQUE, APPLICATION SPLASH, POUR PRODUIT VENTE OU ÉCHANTILLON. MATIÈRE NOBLE AYANT UN POIDS QUALITATIF

POSSIBILITÉ DE PACKS COMPLETS AVEC NOTRE GAMME DE FLAÇONS EN VERRE ÉTRÉ.



# VIROSPACK



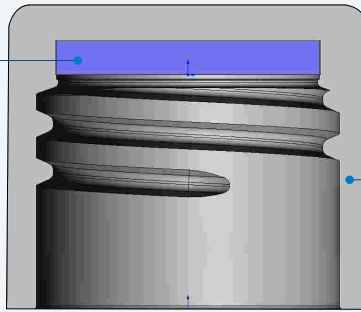















WASHER



CAP



## STANDARD

	MODEL		 Ø (mm)	 H (mm)	INNER CAP
	TC.130	13/410 GCMI	15.2	10.0	UREA
	TC.130e	13/410 GCMI	16.0	10.5	PP
	TC.135	13/415 GCMI	16.0	13.5	UREA
	TC.135e	13/415 GCMI	15.9	12.7	UREA / PP
	TC.155	15/415 GCMI	17.6	15.3	UREA
	TC.155e	15/415 GCMI	18.5	15.5	UREA
	TC.185	18/415 GCMI	21.0	18.3	UREA
	TC.185e	18/415 GCMI	21.3	19.1	UREA
	TA.185	18/415 GCMI	21.5	25.7	UREA
	TC.205	20/415 GCMI	23.1	20.9	UREA
	TC.220	22/410 GCMI	25.1	15.6	UREA
	TR.220	22/410 GCMI	25.4	24.8	UREA
	TC.225	22/415 GCMI	25.2	25.0	UREA
	TR.240	24/410 GCMI	26.7	35.2	UREA
	TC.000	EUROPA 0	11.3	10.0	UREA
	TC.003	EUROPA 3	14.0	11.0	UREA
	TC.004	EUROPA 4	17.0	14.6	UREA
	TC.005	EUROPA 5	21.0	19.1	UREA / PP
	TC.005e	EUROPA 5	21.3	19.1	UREA
	TC.007	EUROPA 7	32.0	26.7	UREA
	TR.PH18	PH18	22.2	11.3	UREA

Realización de modelos específicos bajo consulta

Please consult us about custom designed models.

Développement de spécificques sur consultation.



© Copyright 2003 Virospack Export S.L.

REV. 16/07/07

Esta información ha de considerarse como guía ya que está sujeta a posibles futuros cambios sin previo aviso.  
The information shown above is intended as a guide only and may be subject to change without prior notification.  
Les informations ci-dessus mentionnées sont données à titre indicatif et sont sujettes à d'éventuels changements sans pré-avis.



Virospack recomienda realizar pruebas de compatibilidad con todos los materiales. Nuestro servicio de pruebas de compatibilidad está al alcance de todos nuestros clientes.  
Virospack recommends that all materials are subject to compatibility testing. A compatibility testing service is available to all clients.  
Virospack recommande des tests de compatibilité pour chaque produit à conditionner. Tous nos clients disposent de notre laboratoire pour effectuer ces tests.