	Printed, the document is not a controlled document.		Level:
	<b>952500-4000 Duma Standard</b>		Approved by: <b>CDH 2021.05.11</b>
	Document owner: <b>VriQM</b>	Version: <b>2.26</b>	Implementation: <b>2021.05.11</b>
Document users:	Document no.: <b>1.13.25.1</b>	Standard Product Database	

## Product Specification and Certificate

<b>Product no.</b>	952500-4000
<b>Product name</b>	Duma Standard 2500 ml
<b>Product description</b>	142 mm round plastic container with a snap-on neck to be provided with Duma Handy Cap 9022. Index in the bottom. Intended for the packing of tablets and powder.
<b>Design</b>	<ul style="list-style-type: none"> <li>Regulatory drawing <a href="#">A952500 Regulatory</a></li> <li>Standard drawing <a href="#">B952500</a></li> </ul>
<b>Raw material</b>	Purell PE GF 4760, High-density polyethylene (HDPE) in compliance with Regulation (EU) 10/2011 and FDA title 21 CFR § 177.1520, LyondellBasell Industries. This product meets the standards set by the United States Pharmacopoeia USP 39 <661.1> Plastic Materials of Construction. Coloured with approx. 3.5% white masterbatch, containing approx. 60% titanium dioxide. <a href="#">Purell GF4760 Declaration</a>
<b>Colour</b>	Remafin-EP-White PL00075542-ZT, linear low-density polyethylene (LLDPE) in compliance with Commission Regulation (EU) No 10/2011, FDA title 21 CFR §§ 177.1520 & 178.3297 and BfR recommendation IX, Avient (formerly Clariant). <a href="#">Remafin-EP-White PL00075542-ZT declaration</a>
<b>Production</b>	<b>Facility:</b> Haarby, Denmark <b>Process:</b> The containers are blow moulded <b>Hygiene:</b> The production takes place in clean room <b>Sterilisation:</b> N/A

## Measures and Properties

<b>Dimensions:</b>			
Container:		Neck:	
Outside height	201.0 +2.0/-2.0 mm	Inside diameter	81.6 +0.3/-0.3 mm
Outside diameter	142.0 +1.0/-1.0 mm	Upper outside diameter	90.5 +0.3/-0.3 mm
		Neck ring diameter	94.2 +0.3/-0.3 mm
Wall thickness	Min. 0.4 mm		
<b>Other dimensions:</b>			
Label height	Max. 134 mm	Volume	Max. 2700 ml
Label width	Max. 445 mm	Shelf life	5 years
Weight	109.0 +2.0/-2.0 g	Bioburden	Max. 50 CFU

## Test Results

The container and cap comply with all demands for Moisture Vapour Transmission and Light Transmission and are in accordance with USP <671>. Documentation enclosed. <a href="#">MVT - 952500-4000/009022-4000/NOV2018</a>
--

	Printed, the document is not a controlled document.	Level:
	<b>952500-4000 Duma Standard</b>	Approved by: <b>CDH 2021.05.11</b>
		Implementation: <b>2021.05.11</b>
Document owner: <b>VriQM</b>	Document no.: <b>1.13.25.1</b>	Standard Product Database
Version: <b>2.26</b>		
Document users:		

#### LT - 952500-4000/SEP2019

The container and cap comply with all demands for Internal Reflectance and Differential Scanning Calorimetry and are in accordance with USP <661.1>. Documentation enclosed. Over time IR spectrum might show absorbance from release agent.

[IR - GF4760 / PL00075542-ZT](#)

[DSC HDPE/AUG2016](#)

The container and cap comply with all demands for Physicochemical Tests set by the United States Pharmacopoeia USP 43 <661.2> Plastic Packaging Systems for Pharmaceutical Use and Biological Reactivity Tests, In vitro set by the USP chapter <87>. Documentation enclosed.

[Physico - GF4760/LD653](#)

[In vitro - GF4760/PL00075542/JUN2016](#)

### Packing and Way of Delivery

The products are packed in 1 PE bag, which is then sealed. The PE bag is put into a cardboard carton, which is sealed with PP-tape. The cartons are packed on pallets, which are 1200 x 800 x 140 mm and weight approximately 23 kg.

#### Carton dimensions:

Height (mm): 645                      Length (mm): 830                      Width (mm): 415

#### Packing information:

Number of items per carton: 45                      Volume per carton (m<sup>3</sup>): 0.2142  
 Max. number of cartons per pallet: 9                      Weight per carton (kg.): 6.5  
 Max. height of the pallet (mm): 2300

### Labelling

Each carton is provided with a label with the following information:

- Manufacturer name
- Material name and number
- Batch / lot number and quantity
- Customer information (if requested)
- Country of origin
- Shelf life
- Production date and machine number

### Recommendation to Storage, Handling and Transportation

Stored inside in clean conditions in its original un-open packaging, protected from direct sunlight and with a temperature between 5 - 35° C and Relative Humidity between 30 - 70 %.

### Quality Control

All products are quality controlled according to instructions specified in our quality control system. We therefore guarantee that all deliveries from Primary Packaging Plastics have passed our control procedures and comply with the quality demands mentioned below. If required a certificate of conformance can be issued. The classification of defects and specifications of AQL values are based on ISO 2859 and Quality Assurance of Pharmaceutical and Cosmetic Packaging Materials:  
 Defect Evaluation List for Blow-moulded Plastic Containers Vol. 23 - ISBN 3-87193-405-6.  
 Defect Evaluation List for Injection-moulded parts made of Plastic: Closures, Sealing Disks and dosage aids (droppers, etc.) Vol. 22 - ISBN 3-87193-182-9.

	Printed, the document is not a controlled document.	Level:
	<b>952500-4000 Duma Standard</b>	Approved by: <b>CDH 2021.05.11</b>
	Document owner: <b>VriQM</b>	Implementation: <b>2021.05.11</b>
Version: <b>2.26</b>	Document no.: <b>1.13.25.1</b>	Standard Product Database
Document users:		

Documentation enclosed.

[Quality Control - EBM Containers with re-processed material](#)

### Declaration of Conformity

[DoC EP \(GF4760&PL00075542\)](#)  
[DoC Food Law \(GF 4760 & PL00075542-ZT\)](#)  
[DoC TSE/BSE](#)  
[DoC Allergens, Phthalates, BPA, Latex, Melamine](#)  
[DoC TBA\\_TCA](#)

### Information on Packaging and Packaging Waste Directive 94/62/EC and/or CONEG

Both container, cap and bag are produced from material, which complies with the directions for plastics material in contact with foodstuffs. The content of heavy metals in the products, the inner bag, and the carton is less than 100 ppm.  
The packaging is recyclable for material recovery and/or well suited for energy recovery due to its high energy density. Reuse is technically possible depending on applicable regulations.

### REACH

We can confirm that the raw materials used in the product are either pre-registered or exempted from pre-registration.

### Complaint Handling

In case that the delivered products are outside specification, complaint must be send in writing to daily contact person in Customer Care Center.

In order to ensure a thorough investigation it is important to send the following basic information:

- Article number
- Batch number
- Cavity number (if related to specific cavities)
- Number of defective items
- Defect observed in
  - a) incoming control including sample size
  - b) production including quantity of items used
  - c) final products including quantity of items used
  - d) market complaint
- Defect found in
  - a) one carton
  - b) several cartons - please specify quantity
- Exact production date/time from carton/bag or carton/bag/pallet number products in quarantine:
  - a) Filled products - Quantity
  - b) Not filled products - Quantity
  - c) No products left
- Description of the defect

The following standard form can be used: 3.1 Customer Complaint Report.

Depending on the defect, additional information will be requested as described in the attached standard forms: 2.5 Information requested in relation to complaints.

	Printed, the document is not a controlled document.	Level:
	<b>952500-4000 Duma Standard</b>	Approved by: <b>CDH 2021.05.11</b>
	Document owner: <b>VriQM</b>	Implementation: <b>2021.05.11</b>
Version: <b>2.26</b>	Document no.: <b>1.13.25.1</b>	Standard Product Database
Document users:		

It is very important to send samples at the time a complaint is filed, as any delay in these can have an impact on time of investigation. An investigation report is send to Customer within 21 days counting from when complaint, relevant information and samples are received.

**Important !**

Filled or empty products involved in a complaint to Primary Packaging Plastics, must only be destroyed by Customer after written approval from Gerresheimer. Any activity in connection with a complaint where Customer expect Gerresheimer to cover the costs must be approved by Gerresheimer in writing before initiation of the activity.

[Complaint report](#)

[Labelling](#)

[Loose silica gel-loose desiccant-defect on desiccant](#)

[Mix-up](#)

[Partly- or disconnected TE-rings](#)

[Product defect](#)

[Transport](#)

**Registrations and Certifications**

**Primary Packaging Plastics was established in 2020. Before that time the company was working under the following names: Gerresheimer Plastic Packaging, Superfos Pharma, Superfos Pharma Pack, Dudek Plast and Duma.**

Documentation, i.e. test reports, certificates etc. issued before July 2020 will be with reference to one of the names above.

**Gerresheimer Vaerloese A/S has obtained the following registrations and certifications for Vaerloese and Haarby, Denmark:**

ISO 9001, no. 160454-2014-AQ-DEN-DANAK

ISO 14001, no. 156579-2014-AE-DEN-DANAK

ISO 15378, no. 160455-2014-Q-DEN-DNV

ISO 45001, no. 10000341648-MSD-DANAK-DNK

**The product is FDA registered in US with the following DMF number:**

DMF 12077 – DMF type III Packaging material, Manufactured in Vaerloese - Denmark, Haarby - Denmark.

**The product is TPD registered in Canada with the following DMF number:**

DMF 2000-108 - Packaging material – Drug Master File. Packaging material, Manufactured in Vaerloese - Denmark, Haarby - Denmark.

**China registration for appropriate products - pending.**

**The product is registered in Russia with the following number:**

C3 2011/11203 – plastic packages in size between 3ml to 3000 ml with accessories.

**The product is registered in Ukraine with one of the following numbers:**

10787/2011

	Printed, the document is not a controlled document.		Level:
	<b>952500-4000 Duma Standard</b>		Approved by: <b>CDH 2021.05.11</b>
			Implementation: <b>2021.05.11</b>
Document owner: <b>VriQM</b>			
Version: <b>2.26</b>			
Document users:	Document no.:	Standard Product Database	
	<b>1.13.25.1</b>		

10785/2011
10786/2011
14788/2015
14789/2015

## Revisions

Version:	Implementation:	Revision information:
<a href="#">1</a>	2017.10.23	Created
<a href="#">1.1</a>	2017.10.26	DoC TSE/BSE: Updated (yearly update)
<a href="#">1.2</a>	2017.11.27	DoC Food Law (GF 4760 & PL00075542-ZT): Updated Regulation 2017/752
<a href="#">1.3</a>	2017.11.28	DoC Allergens, Phthalates, BPA, Latex, Melamine: Yearly update
<a href="#">1.4</a>	2018.01.17	Remafin-EP-White PL00075542-ZT declaration: Updated with ICHQ3D
<a href="#">1.5</a>	2018.02.12	Purell GF4760 Declaration: New SVHC list 15.01.2018
<a href="#">1.6</a>	2018.02.27	Remafin-EP-White PL00075542-ZT declaration: Updated
<a href="#">1.7</a>	2018.04.03	Remafin-EP-White PL00075542-ZT declaration: Updated
<a href="#">1.8</a>	2018.05.14	Purell GF4760 Declaration: Updated
<a href="#">1.9</a>	2018.05.28	IR - GF4760 / PL00075542-ZT: Updated
<a href="#">1.10</a>	2018.07.30	Purell GF4760 Declaration: Updated SVHC list 27.06.2018
<a href="#">1.11</a>	2018.08.13	Remafin-EP-White PL00075542-ZT declaration: Updated due to regulation 2016/1416
<a href="#">1.12</a>	2018.09.11	Remafin-EP-White PL00075542-ZT declaration: Updated
<a href="#">1.13</a>	2018.09.18	Purell GF4760 Declaration: Updated due to regulation 2016/1416 Remafin-EP-White PL00075542-ZT declaration: Updated
<a href="#">1.14</a>	2018.10.10	DoC Food Law (GF 4760 & PL00075542-ZT): Updated
<a href="#">1.15</a>	2018.11.20	GF 4760 - White: Unified description
<a href="#">1.16</a>	2019.01.21	Purell GF4760 Declaration: Updated SVHC list 15.01.2019
<a href="#">1.17</a>	2019.01.28	DoC EP (GF4760&PL00075542): Updated
<a href="#">1.18</a>	2019.02.11	Remafin-EP-White PL00075542-ZT declaration: Updated with 37/2019
<a href="#">1.19</a>	2019.02.21	Registrations and Certifications: Updated - China registration.
<a href="#">1.20</a>	2019.03.07	DoC EP (GF4760&PL00075542): Corrected
<a href="#">1.21</a>	2019.03.25	DoC TSE/BSE: Yearly update DoC Allergens, Phthalates, BPA, Latex, Melamine: Yearly update
<a href="#">1.22</a>	2019.04.30	IR/DSC - General: Text updated
<a href="#">1.23</a>	2019.05.15	IR - GF4760 / PL00075542-ZT: Updated
<a href="#">1.24</a>	2019.07.31	Purell GF4760 Declaration: Updated SVHC list_ 16.07.2019
<a href="#">1.25</a>	2019.09.03	Labelling: Updated
<a href="#">1.26</a>	2019.09.17	Purell GF4760 Declaration: Updated with 2019/1338
<a href="#">2</a>	2019.09.30	LT and MVT test updated
<a href="#">2.1</a>	2019.10.21	Remafin-EP-White PL00075542-ZT declaration: Updated with 2019/1338

	Printed, the document is not a controlled document.		Level:
	<b>952500-4000 Duma Standard</b>		Approved by: <b>CDH 2021.05.11</b>
			Implementation: <b>2021.05.11</b>
Document owner: <b>VriQM</b>			
Version: <b>2.26</b>			
Document users:	Document no.:	Standard Product Database	
	<b>1.13.25.1</b>		

<a href="#">2.2</a>	2020.01.28	DoC Food Law (GF 4760 & PL00075542-ZT): Yearly update
<a href="#">2.3</a>	2020.03.17	Purell GF4760 Declaration: Updated SVHC List_16.01.2020
<a href="#">2.4</a>	2020.03.24	DoC TSE/BSE: Yearly updated
<a href="#">2.5</a>	2020.04.14	Registrations and Certifications: Updated name to Primary Packaging Plastics DoC TSE/BSE: Updated name to Primary Packaging Plastics DoC Allergens, Phthalates, BPA, Latex, Melamine: Updated name to Primary Packaging Plastics
<a href="#">2.6</a>	2020.04.16	DoC TBA_TCA: Updated
<a href="#">2.7</a>	2020.04.20	DoC EP (GF4760&PL00075542): New division name_Primary Packaging Plastic
<a href="#">2.8</a>	2020.04.29	Complaint handling: New division name_Primary Packaging Plastic
<a href="#">2.9</a>	2020.05.19	IR - GF4760 / PL00075542-ZT: Updated
<a href="#">2.10</a>	2020.07.01	Purell GF4760 Declaration: Updated SVHC List_25.06.2020
<a href="#">2.11</a>	2020.08.18	Registrations and Certifications: ISO 45001 obtained Physico - GF4760/LD653: Physicochemical test updated
<a href="#">2.12</a>	2020.08.19	Physico/In vitro - General: USP 43 <661.2>
<a href="#">2.13</a>	2020.08.25	Quality Control - General text: Updated name Primary Packaging Plastics
<a href="#">2.14</a>	2020.09.27	Clariant PL00075542-ZT: Clariant name change to Avient
<a href="#">2.15</a>	2020.10.19	Remafin-EP-White PL00075542-ZT declaration: Food contact and FDA declarations updated with a new Logo
<a href="#">2.16</a>	2021.01.15	DoC Food Law (GF 4760 & PL00075542-ZT): Yearly update
<a href="#">2.17</a>	2021.01.26	Purell GF4760 Declaration: Updated SVHC List 19.01.2021
<a href="#">2.18</a>	2021.03.03	Quality Control - EBM Containers with re-processed material: Updated with Primary Packaging Plastics
<a href="#">2.19</a>	2021.04.15	DoC EP (GF4760&PL00075542): Yearly update and change of company logo DoC Food Law (GF 4760 & PL00075542-ZT): Updated
<a href="#">2.20</a>	2021.04.22	Labelling Loose silica gel-loose desiccant-defect on desiccant
<a href="#">2.21</a>	2021.04.23	Packing and Packing waste directive: Updated. Partly- or disconnected TE-rings Product defect Transport IR - GF4760 / PL00075542-ZT: Yearly update
<a href="#">2.22</a>	2021.04.27	Complaint report DoC TSE/BSE: Change of company logo
<a href="#">2.23</a>	2021.05.04	Mix-up
<a href="#">2.24</a>	2021.05.07	Labelling
<a href="#">2.25</a>	2021.05.10	Loose silica gel-loose desiccant-defect on desiccant Mix-up Partly- or disconnected TE-rings Product defect Transport
<a href="#">2.26</a>	2021.05.11	Complaint report

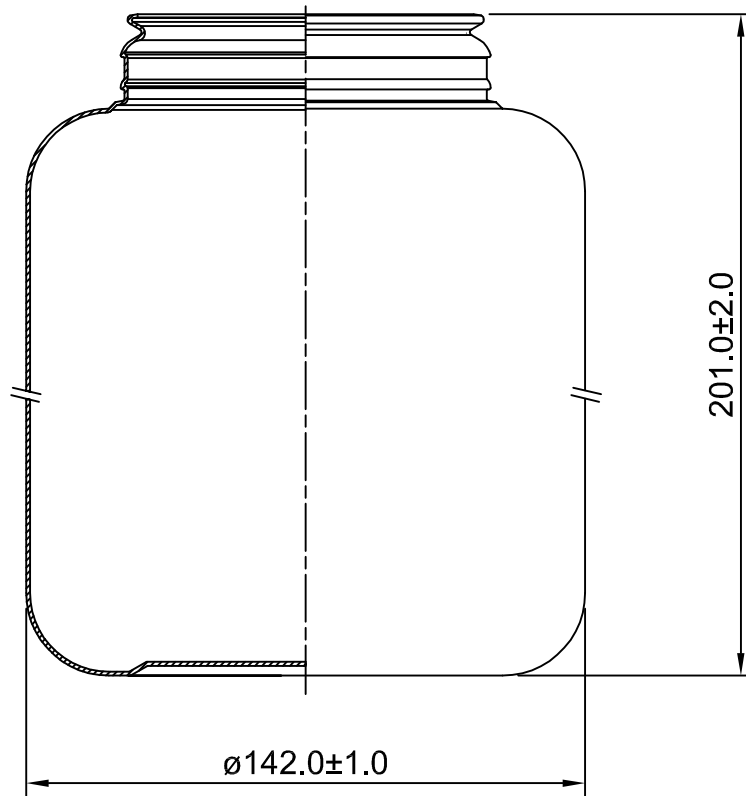

Round 2500ml				
Replaced drawing				
Designer	Hek	12.01.2015	Gerresheimer Vaerloese A/S Walgerholm 2-8, Postbox 229 DK-3500 Vaerloese	
Released	BS	12.01.2015	Phone +45 4477 7888 Fax. +45 4477 7892	
Scale	Drawing Type	Size	This drawing may not be handed over, copied or used by others	
1 : 2	Regulatory	A4	Item <b>Duma Standard</b> <b>952500</b>	
			No. <b>A952500</b>	
			Vers. no.: 1	



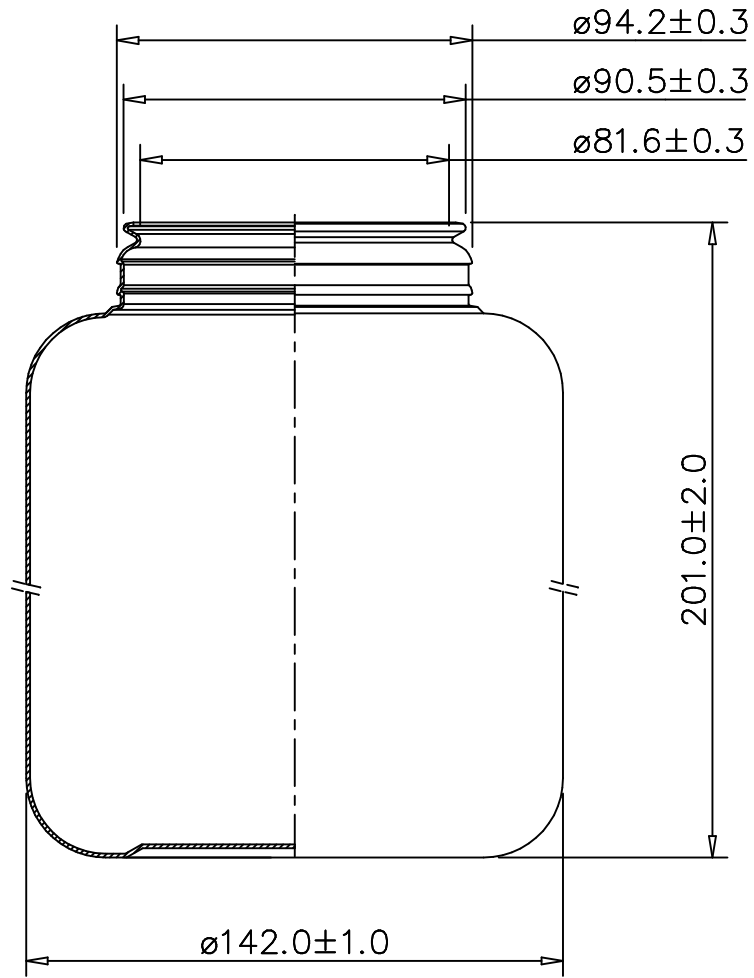
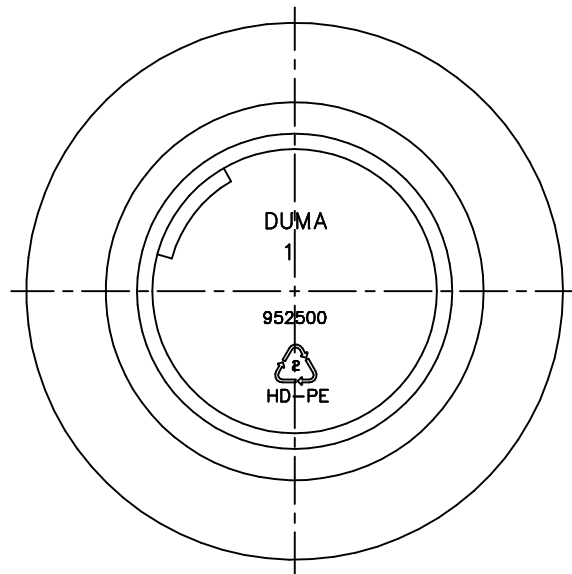

Tolerance changed	03.03.2010	MG	03.03.2010	
Tolerance changed	29.12.2009	MG	29.12.2009	
Tolerance changed	25.09.2009	MG	25.09.2009	
Logo changed	19.06.2009	JJ	19.06.2009	
No. and logo changed	17.03.2006	JJ	17.03.2006	
Drawing nr. reduced	12.2005	JJ	12.2005	
Dimension erased	08.2005	JJ	08.2005	
Created	05.2000	JJ	05.2000	
Created / Correction	Date	Sign.	Appr. Date	Sign.

**GERRESHEIMER**

Gerresheimer Vaerloese A/S  
 Walgerholm 2-8, Postbox 229 Phone +45 4477 7888  
 DK-3500 Vaerloese Fax. +45 4477 7892

This drawing may not be handed over, copied or used by others

Item	No.
Duma Standard	B952500
952500 2500ml.	Vers. no.: 1



January 26, 2021

Katarzyna Jawor  
Gerresheimer Boleslawiec S.A.  
Gerresheimer Boleslawiec S.A.  
Boleslawa Chrobrego 15  
59 700 Boleslawiec



***Purell PE GF4760***

A product of Basell Sales & Marketing Company B.V.; Delftseplein 27E 3013 AA; Rotterdam, Netherlands

Dear Katarzyna Jawor:

The following is in response to your request for Product Stewardship Information (PSInfo) for the product listed above. The attached Product Stewardship Bulletin (PSB) details the regulatory status of this product.

LyondellBasell Industries responds to product stewardship requests with a standardized Product Stewardship Bulletin (PSB) which summarizes the global regulatory status of a product. LyondellBasell Industries will not complete customers' forms or questionnaires. Standardized responses provide each customer with consistent information in a timely fashion. Each request is reviewed to ensure our response documents provide relevant information.

Please note that compliance with these regulations should not be interpreted to guarantee that the product, will, in fact, perform in a particular application. Your Technical Service Representative can help you determine that the characteristics of the product are compatible with the desired conditions of use.

Should you have any further questions concerning a LyondellBasell product, or if we can assist in any other way, please do not hesitate to contact us.

Best regards,

A handwritten signature in grey ink, appearing to read 'M. Poltronieri'.

Micaela Poltronieri  
Product Safety Specialist  
+39 0532 46 8087  
micaela.poltronieri@lyondellbasell.com

# Product Stewardship Bulletin



## ***Purell* PE GF4760**

A product of Basell Sales & Marketing Company B.V.; Delftseplein 27E 3013 AA; Rotterdam, Netherlands

### **Global Food Contact Status:**

#### **European Union**

This product complies with the relevant requirements of Regulation 1935/2004/EC (Framework Regulation) as applicable to intermediate materials (e.g. plastic powders, plastic granules or plastic flakes).

This product complies with the relevant requirements of Regulation 2023/2006/EC (GMP) and as amended, applicable to intermediate materials (e.g. plastic powders, plastic granules or plastic flakes).

This product complies with the relevant requirements of Regulation 10/2011/EC (PIM) as amended, applicable to intermediate materials (e.g. plastic powders, plastic granules or plastic flakes).

The monomers and additives used to produce this product are listed in the Union List of Authorized Substances of Regulation 10/2011/EC and subsequent amendments.

EU Regulation 10/2011/EC specifies 10 mg/dm<sup>2</sup> as the maximum overall migration (OML) from the finished plastic food contact material or article. The OML and SMLs (when applicable) should be determined according to the requirements specified in EU Regulation 10/2011/EC and subsequent amendments. The OML and SML determinations are the responsibility of the manufacturer of the finished plastic food contact material or article. In addition, we remind you that the manufacturers of the finished food contact material or article must verify that the finished material or article, manufactured according to good manufacturing practices, does not modify the organoleptic properties of the food.

#### SML Components

This product contains one or more components with Specific Migration Limits (SMLs).

93280; distearylthiodipropionate; SML(T) = 5 mg/kg (14).

68320; Octadecyl 3(3,5-Di-tert-butyl-4-hydroxyphenyl) propionate; SML = 6 mg/kg

This product contains traces of a substance which is regulated with a specific migration limit in EU (Commission Regulation 10/2011; Annex II). Migration tests showed a migration level significantly below the SML, thus exceeding this SML under foreseeable conditions of use involving food contact is not expected.

SML = 1 mg/kg (expressed as Aluminium)

This product contains one or more Dual Use Additives as defined in Regulation 10/2011/EC.

- ▶ E 470a Calcium salts of fatty acids

## **United States**

The base resin in this product meets the FDA requirements contained in the Code of Federal Regulations in 21 CFR 177.1520(a)(3)(i) and (c)3.2a.

This product may also contain adjuvant substances that may be safely used in polymers used for the manufacture of articles that come into direct contact with food. According to our information, the substances used in this product meet the requirements of their respective FDA regulations and 21 CFR 177.1520(b).

This product meets the FDA criteria in 21 CFR 177.1520 for food contact applications, including cooking, listed under conditions of use A through H in 21 CFR 176.170(c), Table 2, and can be used in contact with all food types as listed in 21 CFR 176.170(c), Table 1.

## **Japan**

Food Contact Positive Lists by Japan's Ministry of Health, Labour and Welfare (MHLW) issued on April 28th, 2020 and effective on June 1st, 2020

The base resin of this product is listed in the Positive List of Base Polymers.

The additive(s) used in this product is/are listed in the Positive List of Additives authorized for use in the Base Resin of this product.

## **Allergen Statements**

### **Allergen - Food Allergen European Regulation 1169/2011**

The food ingredients listed in Annex II of Regulation (EU) No 1169/2011, are not used in the manufacture of or formulation of this product. However, this product has not been tested for these substances.

## **Biomedical Policy**

This product(s) may not be used in:

(1) U.S. FDA Class III, Health Canada Class IV, and/or European Class III Medical Devices; or (2) applications involving permanent implantation into the body.

Prior written approval for each specific product and application must be given by LyondellBasell before this product(s) is used in any:

(1) U.S. FDA Class I, Health Canada Class I, and/or European Union Class I Medical Devices; (2) U.S. FDA Class II, Health Canada Class II or Class III, and/or European Union Class II Medical Devices; (3) film, overwrap and/or product packaging that is considered a part or component of one of the aforementioned Medical Devices; or (4) packaging in direct contact with a pharmaceutical active ingredient and/or dosage form that is intended for inhalation, injection, intravenous, nasal, ophthalmic (eye), digestive, or topical (skin) administration

All references to U.S. FDA, Health Canada, and European Union regulations include other country's equivalent regulatory classifications.

LyondellBasell may further prohibit or restrict the sale of its products into certain applications. For further information, please contact a LyondellBasell representative or visit the LyondellBasell website at:

<https://www.lyondellbasell.com/en/products-technology/product-safety-stewardship/>

### **Animal Based Raw-Materials (BSE/TSE)**

#### **Tallow**

Tallow derived additives may be used in the manufacture of this product.

#### **Europe - BSE/TSE - "Mad Cow"**

Tallow derived materials used in this product fulfill the requirements laid down in the Regulations 1069/2009/EC, and 142/2011/EC, and the "Note for Guidance EMA/410/01, and as amended.

#### **Epoxy Derivatives**

The materials BADGE, BFDGE or NOGE are not intentionally added in this product as referenced in Commission Regulation 1895/2005/EC, on the use of certain epoxy derivatives in materials and articles intended to come into contact with foodstuffs as plasticizers, additives or raw materials.

#### **California Prop 65**

Please refer to the US SDS for communications regarding California Proposition 65. In case the US SDS is not available, please contact [global.chem.control@lyondellbasell.com](mailto:global.chem.control@lyondellbasell.com).

#### **Conflict Minerals (Dodd-Frank Wall Street Reform and Consumer Protection Act - September, 2010)**

Please see link below for the position of LyondellBasell concerning this Act:

<https://www.lyondellbasell.com/en/investors/corporate-governance/?id=52>

The link to this document is located in the right margin under the heading "Corporate Governance Documents" titled "Conflict Minerals Policy".

### **Genetically Modified Organisms (GMO)**

Additives derived from Genetically Modified Organisms (GMO's) are not intentionally used in the formulation of this product.

### **Halal Certification**

This product is not certified as Halal.

### **Kosher Certification**

This product is not certified Kosher.

### **Latex**

No materials containing latex or natural rubber are used in the manufacturing, handling and packaging processes for this product.

### **Medical**

#### **European Pharmacopeia (EP)**

This product meets the requirements of the monographs 3.1.3 ( Polyolefins ) and 3.1.5 (Polyethylene with additives for containers for parenteral preparations and for ophthalmic preparations) - European Pharmacopoeia Edition 10.

#### **ISO 10993**

Biological reactivity evaluations have been performed on representative samples of this product according with the requirements of USP 661.1; specifically the Chapter 88 - USP Biological Reactivity Tests, In Vivo for a Class VI plastic (Systemic Injection Test, Intracutaneous Test, Implantation Test) and Chapter 87 - Biological Reactivity Tests, in Vitro for polymeric materials (Elution Test). These USP tests may fit the requirements of certain sections of ISO 10993-5 (tests for in vitro cytotoxicity), 10993-10 (tests for irritation and skin sensitization) and 10993-11 (tests for systemic toxicity). Despite this, the manufacturer of a medical device made with this product must still evaluate the medical device to show that it fully meets the requirements of the applicable sections of ISO 10993.

#### **US Pharmacopeia (USP)**

Representative samples of this product meet the requirements of USP Chapter 661.1 (Edition USP 39).

## US FDA Drug Master File (DMF)

Information on this product is listed in DMF N. 5654. Contact LyondellBasell for a DMF authorization letter to be sent to FDA.

## ICH Harmonized Guideline Q3D (Elemental Impurities)

The elemental impurities of Class 1, 2, 3 listed in the ICH Harmonized Guideline Q3D of 22 March 2019 are not intentionally used in the manufacture or formulation of this product. However this product has not been tested for these substances.

## Metals Content

## US CONEG

Based on the available documentation provided by our raw material suppliers, this product complies with the CONEG Model Legislation for requirements regarding the defined limit for the sum of heavy metals (lead, mercury, cadmium and hexavalent chromium).

## EU Packaging and Packaging Waste

Based on the available documentation from raw materials suppliers, this product complies with the directive 94/62/EC and as amended concerning the defined limit(s) of heavy metals.

## Restriction of Hazardous Substances in Electric and Electronic Equipment (RoHS)

RoHS Regulation refers to electrical and electronic equipment and not specifically to plastic raw materials. However, based on the available documentation from raw materials suppliers, this product complies with the requirements of the Directives 2002/95/EC and 2011/65/EU, as amended, concerning the limits of cadmium, lead, mercury, hexavalent chromium, polybrominated biphenyls (PBB), polybrominated diphenyl ethers (PBDE), bis(2-ethylhexyl)phthalate (DEHP), butyl benzyl phthalate (BBP), Dibutyl phthalate (DBP) and diisobutyl phthalate (DIBP).

## Nanomaterials

Nanomaterials (defined as natural, incidental or manufactured materials containing particles, in an unbound state or as an aggregate or as an agglomerate and where, for 50 % or more of the particles in the number size distribution, one or more external dimensions is in the size range 1 nm - 100 nm) are not used in the manufacture of or the formulation of this grade. However, this product has not been tested for these chemical substances.

## Other Chemicals

The chemical materials listed below are not intentionally used in the manufacture or the formulation of this product. However, this product has not been tested for these chemical materials.

- ▶ 2-(2H-1, 2, 3-Benzotriazol-2-yl)-4,6-di-tert-butylphenol; (Benzotriazole); CAS# 3846-71-7;
- ▶ 2,4,4'-trichloro-2'-hydroxydiphenyl ether; (Triclosan); CAS# 3380-34-5;

- ▶ 2-mercaptobenzothiazole; MBT; CAS# 149-30-4;
- ▶ Acrolein; (propenal); (CAS# 107-02-8);
- ▶ Acrylamide; CAS# 79-06-1;
- ▶ Aromatic amines;
- ▶ Asbestos;
- ▶ Azo Dyes and Pigments;
- ▶ Polyaromatic Hydrocarbons - PAHs:
  - 1,2-dihydro-acenaphthene; (CAS# 83-32-9);
  - 9H-Fluorene; (CAS# 86-73-7);
  - Acenaphthylene; (CAS# 208-96-8);
  - Anthracene; (CAS# 120-12-7);
  - Benz(a)anthracene; (CAS# 56-55-3);
  - Benzo(a)pyrene; (CAS# 50-32-8);
  - Benzo(b)fluoranthene; (CAS# 205-99-2);
  - Benzo(e)pyrene; (CAS# 192-97-2);
  - Benzo(ghi)perylene; (CAS# 191-24-2);
  - Benzo(j)fluoranthene; (CAS# 205-82-3);
  - Benzo(k)fluoranthene; (CAS# 207-08-9);
  - Chrysene; (CAS# 218-01-9);
  - Dibenz(a,h)anthracene; (CAS# 53-70-3);
  - Fluoranthene; (CAS# 206-44-0);
  - Indeno(1,2,3-cd)pyrene; (CAS# 193-39-5);
  - Naphthalene; (CAS# 91-20-3);
  - Phenanthrene; (CAS# 85-01-8);
  - Pyrene; (CAS# 129-00-0);
- ▶ Benzophenone; CAS RN 119-61-9;
- ▶ Bisphenol A; (BPA); CAS# 80-05-7;
- ▶ Bisphenol A diglycidyl ether; (BADGE); CAS# 1675-54-3;
- ▶ Bisphenol F diglycidyl ether; BFDGE; CAS# 2095-03-6;
- ▶ Butylated hydroxyanisole; (BHA); CAS# 121-00-6 & 25013-16-5;
- ▶ Butylated hydroxytoluene; (BHT); CAS# 128-37-0
- ▶ Chlorinated paraffins;
- ▶ Cyanuric acid; (Isocyanuric Acid or CYA); CAS# 108-80-5;
- ▶ Dimethyl fumarate; (DMF); CAS# 624-49-7;
- ▶ Dioxins;
- ▶ Epichlorohydrin; (ECH); CAS# 106-89-8;
- ▶ Fluorocarbons;
- ▶ Fluorotelomers
- ▶ Formaldehyde; CAS# 50-00-0;



- ▶ Formaldehyde in specific conditions could be formed during further resin processing (see SDS)
- ▶ Gold(Au); CAS# 7440-57-5;
- ▶ Halogenated Flame Retardants
- ▶ Melamine; (1,3,5-Triazine-2,4,6-triamine); CAS# 108-78-1;
- ▶ Nitrosamines;
- ▶ Nonylphenol; CAS# 25154-52-3;
- ▶ Nonylphenol ethoxylates;
- ▶ Novolac glycidyl ether;
- ▶ Organotin compounds;
- ▶ Perfluorochemicals; (PFCs);
- ▶ Perfluorooctane sulfonate; (PFOS); CAS# 1763-23-1;
- ▶ Perfluorooctanoic acid; (PFOA); CAS# 335-67-1;

Plasticizers (e.g. DEHA, DINCH, BTHC, TOTM, etc.):

DEHA bis(2-ethylhexyl) adipate; CASRN: 103-23-1

DINCH 1,2-Cyclohexanedicarboxylic acid, 1,2-diisononyl ester, CASRN: 166412-78-8

BTHC butyryl tri-n-hexyl citrate; CASRN: 82469-79-2;

TOTM tris(2-ethylhexyl)benzene-1,2,4-tricarboxylate; CASRN: 3319-31-1

DINP; Diisononyl Phthalate; CASRN: 28553-12-0;

DEHP; di(2-ethylhexyl) phthalate

DOP; di-octyl phthalate; CASRN: 117-81-7;

DIDP; di-iso-decyl phthalate; CASRN: 26761-40-0;

DBP; di-butyl phthalate; or DNBP; di-n-butyl phthalate; CASRN 84-74-2;

BBP; butyl benzyl phthalate; CASRN 85-68-7;

DNOP; di-n-octyl phthalate; CASRN: 117-84-0;

Glycerides, castor-oil mono-, hydrogenated, acetates; CASRN: 736150-63-3

- ▶ Polybrominated biphenyls; (PBBs);
- ▶ Polybrominated diphenyl ethers; (PBDEs);
- ▶ Polybrominated terphenyls; (PBTs);
- ▶ Polychlorinated biphenyls; (PCBs);
- ▶ Polychlorinated naphthalenes; (PCNs);
- ▶ Polychlorinated terphenyls; (PCTs);
- ▶ Polystyrene;
- ▶ Polyvinyl chloride; (PVC); CAS# 9002-86-2;
- ▶ Radioactive substances;
- ▶ Radon; CAS# 10043-92-2;
- ▶ Styrene monomer; CAS# 100-42-5;
- ▶ Sulphur dioxide; CAS# 7446-09-5;

- ▶ Tin oxide (SnO<sub>2</sub>); (Cassiterite); CAS# 8062-08-6;
- ▶ Tris-nonylphenol phosphite; (TNPP); CAS# 26523-78-4;
- ▶ Vinyl chloride monomer; CAS RN 75-01-4; VCM
- ▶ Wolframite; Tungsten (W); CAS# 1332-08-7;

## Ozone Depleting Substances

### European Union

The ozone-depleting substances (ODS), listed in the Annexes I & II of the Regulation ( EC ) No 1005/2009 of 16 September 2009, are not intentionally used in the manufacture of or formulation of this product.

### United States

Materials listed in the Clean Air Act Amendments of 1990 (Class I, CFCs and Class II, HCFC's, Halons and the solvents, carbon tetrachloride and 1,1,1-trichloroethane) are not intentionally used in the production of this product.

### Phthalates

Phthalates are not used in the manufacture of or the formulation of this product. However, this product has not been tested for phthalates.

### REACH Substances of Very High Concern (SVHC)

This product does not contain any of the Annex XIV substances on the Authorisation list or Annex XIV candidate chemicals proposed to be Substances of Very High Concern for Authorisation (List as of January 19, 2021) above the 0.1 % threshold as stated in REACH (Article 57, Regulation No. 1907/2006) determined either through (i) non-use of the substance, (ii) mass balance calculation, or (iii) specific testing. The current list of all SVHCs can be found at ECHA website link listed below:

<https://www.echa.europa.eu/candidate-list-table>

### Global Chemical Control Regulations

All ingredients in this product are in compliance with the following chemical inventories:

See Section 15, of the SDS (Safety Data Sheet) for Global Chemical Inventories.

### Global Toy Regulations

CEN EN Standards refer to safety of toys and not specifically to plastic raw materials. According to the information provided by our raw material suppliers, we deem this product should comply with the requirements of CEN standards EN71-3 / EN71-9 (as amended) as applicable to plastic raw materials (pellets, powder, flakes). However, this product has not been tested according to these CEN Standards.

## **VOC Content**

### **Switzerland VOC Declaration**

This product contains less than 3% VOC's of the substances in the positive lists of the Switzerland Regulations "VOC-LENKUNGSABGABE."

### **CEN Standard EN 13432:2004**

This product is not suitable for composting.

### **Energy Recovery - CEN Standard EN 13431:2004**

The calorific gain from polyethylene in an energy recovery process is 22 MJ/Kg.

### **Disclaimer on Pass/Fail Status**

Compliance statements, or statements regarding pass/fail status provided by Seller in this document are based on testing of representative samples and/or product composition assessment.

Seller makes no express or implied warranty by virtue of disclosing compliance or pass/fail status.

### **Disclaimer**

Information in this document is accurate to the best of our knowledge at the date of publication. The document is designed to provide users general information for safe handling, use, processing, storage, transportation, disposal and release and does not constitute any warranty or quality specification, either express or implied, including any warranty of merchantability or fitness for any particular purpose. Users shall determine whether the product is suitable for their use and can be used safely and legally.

In addition to any prohibitions of use specifically noted in this document, LyondellBasell may further prohibit or restrict the sale of its products into certain applications. For further information, please contact a LyondellBasell representative.

### **Trademarks**

The Trademark referenced within the product name is owned or used by the LyondellBasell family of companies.

Gerresheimer Boleslawiec S.A

ul. Bolesława Chrobrego 15  
PL - 59-700 Boleslawiec  
Poland

0000145632

33924010

08.10.2020

---

## Declaration

---

### **REMAFIN-EP-WHITE PL00075542-ZT**

#### **Introduction**

This declaration applies exclusively to the above-mentioned product when used as colouring or additive agent of a plastic food contact material and article. Our mixture is not intended to come directly in contact with food in its original form: therefore, since Avient has no influence on subsequent processing, this declaration cannot be extended to the finished material or article. Indeed, the compliance of the end material or article with the food contact regulations is the responsibility of the converter. He is committed to meet all relevant legal requirements and to test the migration limits according to the conditions of use (temperature, time, simulants) of the article in its finished form (e.g. volume, geometry, thickness). These conditions are not part of our knowledge and therefore are not under Avient's control.

#### **Framework Regulation (EC) No. 1935/2004 and GMP Regulation No 2023/2006**

Framework Regulation (EC) No. 1935/2004 sets out the general rules that must be met by all classes of food contact materials without giving any specific rule of how to prove the safety of food contact articles: plastic materials are covered by specific measures in relation to component types used in the formulation of our mixtures:

- polymers and additives are regulated by Regulation (EU) No 10/2011 and its amendments.
- colourants (including dyes, organic and inorganic pigments) must not migrate and must also comply with the purity requirements laid down in the national laws of Member States. General requirements for colourants are listed in the EU Resolution of the Council of Europe, AP (89) 1 though this is not legally binding.
- catalysts, solvents and polymer production aids (not yet listed at EU level) shall be assessed with general rules of the Framework Regulation by the substance manufacturer and/or shall comply with the national legislations provisions.

The product is not expected to cause any contravention to the Framework Regulation since the subsequent stages of manufacture, processing and distribution of the end article are in line with the Good Manufacturing Practices (GMP) applicable to food contact materials and article's supply chain, as listed in Regulation (EC) No 2023/2006. In addition, we would declare that our own production process, as a part of this supply chain will conform to the provisions of GMP.

*Hereafter the status of the different component types is given according to their applicable legislation and based on the declarations received by Avient from starting materials suppliers:*

#### **Commission Regulation (EU) No 10/2011 and its amendments**

All the carriers and the intentionally added additives comply with the requirements of Regulation (EU) No 10/2011 and its amendments published before the release date of this certificate. We would like to remind you that the assessment of overall migration limit, other release restrictions such as those found in Annex II (the release of aromatic amines in a detectable quantity and the specific migration limits for all metals, especially considering low migration limits established) is the responsibility of the producer of the finished article

(converter).

#### **Restrictions and Limitations**

- Aluminium: SML = 1 mg/kg food or food simulant
- Octadecyl 3-(3,5-di-tert-butyl-4-hydroxyphenyl)propionate: SML = 6 mg/kg. Consider correction of specific migration in foods containing more than 20% fat by the fat reduction factor.

#### **Please note, that the following dual-use-additives are contained:**

FCM number / name of the additive / content of the additive (given in range)

610	Titanium dioxide	40 - 60 %
575	Polydimethylsiloxane (Mw > 6800 Da)	0,1 - 0,25 %

SML	Specific Migration Limit	SML(T)	Specific Migration Limit expressed as Total
DL/LR/NG	Detection Limit	FP/PF/BG	Finished Product or Article

#### **European Resolution AP (89) 1**

All the colourants used meet the requirements established in European Resolution AP( 89) 1 in regard to the maximum permissible levels of heavy metals, primary aromatic amines, sulphonated aromatic amines and polychlorinated biphenyls.

#### **Belgium: Arrêté Royal from 11.05.1992 of the Moniteur Belge 24.07.1992**

All the colourants used meet the purity requirements listed in the Arrêté Royal from 11.05.1992 of the Moniteur Belge 24.07.1992 and its amendments.

#### **France: Jorf**

All the colorants fulfil the applicable requirements and restrictions for food contact applications.

#### **Germany: BfR Recommendation IX**

There are no objections to the use of the colourants in this product according to the Recommendation IX of the BfR (Federal Institute for Risk Assessment).

#### **Italy: Decreto Ministeriale**

All the colourants used, meet the purity requirements listed in the Decreto Ministeriale of 21.03.1973 and its amendments.

#### **The Netherlands: Warenwet**

All the colourants used meet the purity requirements listed in the Dutch regulation Warenwet and its amendments.

#### **Spain: Real Decreto 847/2011 (subsecretaria para Sanidad)**

All the colourants used meet the purity requirements listed in Annex II of Real Decreto 847/2011 (subsecretaria para Sanidad) and its amendments.

#### **Turkey: Food Codex Regulation**

All the components used meet the requirements of Turkish Food Codex Regulation on Materials and Articles in Contact with Foodstuffs issued in April 5th, 2018 and its amendments.

*We would also like to inform you of the status of our product in regard to the Directive 94/62/EC, CONEG (Regulation status and the content of diarylide pigments):*

### **Directive 94/62/EC, CONEG and Heavy Metals**

Heavy metals and/or their compounds are not intentionally added by us during production and, on the base of our present knowledge, they are not contained (or are present just as impurity at trace-level) in raw materials which are used for the production of above-mentioned product. In any case, our company does not carry out any specific analysis in order to detect the presence of above mentioned substances and then this statement is based on specific information provided by our raw material suppliers. The product meets the requirements of the EC Directive 94/62/EEC and the CONEG regulation which limits the content of heavy metals up to 100 ppm (Cd, Pb, Hg, Cr(VI)).

### **Diarylide Pigments**

The product does not contain any intentionally added diarylide pigment in its chemical composition.

## **Clariant Plastics & Coatings (Polska) Sp. z o.o.**

This information corresponds to the present state of our knowledge and is intended as a general description of our products and their possible applications. Avient makes no warranties, express or implied, as to the information's accuracy, adequacy, sufficiency or freedom from defect and assumes no liability in connection with any use of this information. Any user of this product is responsible for determining the suitability of Avient's products for its particular application. Nothing included in this information waives any of Avient's General Terms and Conditions of Sale, which control unless it agrees otherwise in writing. Any existing intellectual/industrial property rights must be observed. Due to possible changes in our products and applicable national and international regulations and laws, the status of our products could change. Safety Data Sheets providing safety precautions, that should be observed when handling or storing Avient products, are available upon request and are provided in compliance with applicable law. You should obtain and review the applicable Safety Data Sheet information before handling any of these products. For additional information, please contact Avient.

*\* For sales to customers located within the United States and Canada the following applies in addition:*

**NO EXPRESS OR IMPLIED WARRANTY IS MADE OF THE MERCHANTABILITY, SUITABILITY, FITNESS FOR A PARTICULAR PURPOSE OR OTHERWISE OF ANY PRODUCT OR SERVICE.**

9/2010

**Gerresheimer Boleslawiec S.A****ul. Boleslawa Chrobrego 15****PL - 59-700 Boleslawiec****Poland**

0000145632

33924011

Version : 2 - 5

08.10.2020

---

## Declaration

---

**REMAFIN-EP-WHITE PL00075542-ZT****Material number: PL00075542**

### Introduction

This document is intended to provide information on the current status of the above-referenced material under certain regulatory programs. Please review this document carefully and contact your Avient representative if you have any questions.

All statements refer exclusively to the named product in its current formulation: they are based on the present state of our knowledge and experience and concern the product in its original form and packaging as supplied from our factory.

Since the masterbatch and compound manufacturer has no influence on subsequent processing, the processor himself is responsible for ensuring that the finished article is suitable for the intended use, and is also responsible for ascertaining the compliance of the end article with the national and international regulations and laws concerning its application field. Due to the broad range of possible applications we make no warranty that the actual use of the product in the finished article is comprised by the information below.

*Hereafter the status of the different component types is given according to their applicable legislation and based on the declarations received by Avient from starting materials suppliers:*

### USA Food and Drug Administration

In the USA substances used as a component of articles intended to come into contact with food are regulated by Food and Drug Administration FDA 21 CFR Title 21. Specific limitations and conditions of use, as set forth in these regulations, are specified below.

Please note, the maximum use rate specified below must be met to ensure regulatory compliance.

The components entering into the formulation of the above-referenced product are approved under one or more of the specific FDA paragraphs or have other clearances listed below:



1. Colorants listed in 21 CFR 178.3297 "Colorants for Polymers."
2. Components that are exempt from regulation under 21 CFR 170.39, "Threshold of Regulation for Substances Used in Food Contact Articles."
3. Polymers and/or additives listed in the appropriate parts of 21 CFR (174, 175, 176, 177, 178, 181, 182, 184 and 186).
4. Substances that, based upon legal opinion, supplier certification, and/or extraction results from food-simulating solvents, are not food additives and are acceptable for food contact applications in full compliance with the Federal Food, Drug and Cosmetic Act and all applicable food additive regulations.
5. Substances that are GRAS (Generally Recognized as Safe) for direct addition to food or for use in contact with food.
6. Substances that are "Prior Sanctioned" for use in this application.
7. Substances that are the subject of applicable Food Contact Substance Notifications.

The above statement is valid only if the dosage ratio listed below is not exceeded in the application polymer:

Application polymer	Max. let-down ratio (w/w)
HDPE	33,33 %
The finished articles are to contact food only under conditions of use B through H described in Table 2 of §176.170(c) of 21CFR.	
LLDPE	33,33 %
The finished articles are to contact food only under conditions of use B through H described in Table 2 of §176.170(c) of 21CFR.	
LDPE	33,33 %
The finished articles are to contact food only under conditions of use B through H described in Table 2 of §176.170(c) of 21CFR.	
PP	33,33 %
The finished articles are to contact food only under conditions of use B through H described in Table 2 of §176.170(c) of 21CFR.	

If you do not find your application polymer, please contact your Avient product safety representative.

**Directive 94/62/EC and CONEG**

Based on the knowledge of the raw materials as well as of the manufacturing process this product meets the requirements of the Directive 94/62/EC and the CONEG regulation which limits the content of heavy metals up to 100 ppm (Cd, Pb, Hg, Cr(VI)).

**Diarylide Pigments**

The product does not contain any intentionally added diarylide pigment in its chemical composition.

**Clariant Plastics & Coatings  
(Polska) Sp. z o.o.**

This information corresponds to the present state of our knowledge and is intended as a general description of our products and their possible applications. Avient makes no warranties, express or implied, as to the information's accuracy, adequacy, sufficiency or freedom from defect and assumes no liability in connection with any use of this information. Any user of this product is responsible for determining the suitability of Avient's products for its particular application. Nothing included in this information waives any of Avient's General Terms and Conditions of Sale, which control unless it agrees otherwise in writing. Any existing intellectual/industrial property rights must be observed. Due to possible changes in our products and applicable national and international regulations and laws, the status of our products could change. Safety Data Sheets providing safety precautions, that should be observed when handling or storing Avient products, are available upon request and are provided in compliance with applicable law. You should obtain and review the applicable Safety Data Sheet information before handling any of these products. For additional information, please contact Avient.

\* For sales to customers located within the United States and Canada the following applies in addition:

NO EXPRESS OR IMPLIED WARRANTY IS MADE OF THE MERCHANTABILITY, SUITABILITY, FITNESS FOR A PARTICULAR PURPOSE OR OTHERWISE OF ANY PRODUCT OR SERVICE.

9/2010

Katarzyna Jawor  
Gerresheimer Boleslawiec S.A

PL -  
Poland

31448904

06.02.2019

---

## Declaration

---

### REMAFIN-EP-WHITE PL00075542-ZT

#### Introduction

All statements refer exclusively to the named product in its current formulation: they are based on the present state of our knowledge and experience and concern the product in its original form and packaging as supplied from our factory.

Since the masterbatch and compound manufacturer has no influence on subsequent processing, the processor himself is responsible for ensuring that the finished article is suitable for the intended use, and is also responsible for ascertaining the compliance of the end article with the national and international regulations and laws concerning its application field.

#### Additional information

- Based on the current formulation of the above mentioned product, the following substances have not been intentionally added during its production:

Bisphenol A, Latex, Phthalates, Melamine, Allergens

These substances were not used as starting materials during the mixing phase of our product but, on the basis of our current knowledge, we cannot give you any warranty they are not constitutionally contained (or are present at level of ubiquitous(\*\*) traces) in raw materials. Please note that, in any case our Company does not carry out any specific analysis in order to detect the presence of above mentioned substances.

(\*\*)Ubiquitous in regard to a chemical substance means that this substance is omnipresent (occurs literally everywhere) and its occurrence in this "ubiquitous" traces cannot be avoided by any technical, physical or chemical measure.

#### Additional information

In addition be informed that, in case here above was not clearly mentioned, you can find the following information into the Safety Data Sheet you already got by us:

- the ingredients that may be classified as dangerous for health and environment;
- information on restriction on use that we are aware of and that could be relevant for plastic applications.

## Clariant Plastics & Coatings (Nordic) AB

### Country Product Stewardship

This declaration was produced automatically and therefore does not have an original signature

This information corresponds to the present state of our knowledge and is intended as a general description of our products and their possible applications. Clariant makes no warranties, express or implied, as to the information's accuracy, adequacy, sufficiency or freedom from defect and assumes no liability in connection with any use of this information. Any user of this product is responsible for determining the suitability of Clariant's products for its particular application. Nothing included in this information waives any of Clariant's General Terms and Conditions of Sale, which control unless it agrees otherwise in writing. Any existing intellectual/industrial property rights must be observed. Due to possible changes in our products and applicable national and international regulations and laws, the status of our products could change. Material Safety Data Sheets providing safety precautions, that should be observed when handling or storing Clariant products, are available upon request and are provided in compliance with applicable law. You should obtain and review the applicable Material Safety Data Sheet information before handling any of these products. For additional information, please contact Clariant.

\* For sales to customers located within the United States and Canada the following applies in addition:  
NO EXPRESS OR IMPLIED WARRANTY IS MADE OF THE MERCHANTABILITY, SUITABILITY, FITNESS FOR A PARTICULAR PURPOSE OR OTHERWISE OF ANY PRODUCT OR SERVICE.

9/2010

---

## Declaration

---

REMAFIN-EP-WHITE PL00075542-ZT

### Introduction

All statements refer exclusively to the named product and its current formulation as supplied from our factory in its original form and packaging and are based on the present state of our knowledge and experience.

Since the masterbatch manufacturer has no influence on subsequent processing, the processor himself is responsible for ensuring that the finished article is suitable for the intended use and to ascertain the compliance of the end article with the national and international regulations and laws concerning its application field.

### BSE/TSE:

Based on the knowledge of the raw materials as well as of the manufacturing process, we are able to confirm that the product does not contain intentionally added components of animal origin. They are not used by us during production and, on the base of our present knowledge, are not contained (or are present just as impurities at trace-level) in raw materials which are used for the production of our preparations; please note that in any case, our Company does not carry-out any specific analyses in order to detect the presence of the a.m. substances.

Clariant Plastics & Coatings (Nordic) AB  
Box 9053  
SE-200 39 Malmö  
Phone: +46 40 671 72 00  
E-mail: psmalmo@clariant.com  
Web: www.clariant.com



The attached declaration has been compiled according the best information available to us, and according to the laws in force at the publication date of the document itself. It is forbidden to, entirely or partially, reproduce the present declaration and to issue it to a third party without written assent of Clariant.

**Additional Information**

The information given in the present declaration is based on the current level of our knowledge, and is intended to provide information about our products. It should therefore not be construed as guaranteeing specific properties. Buyer or user are responsible for ensuring that the products they use, as supplied by us, comply with the specific requirements of their intended application.

Due to the progress (evolution) of national and international regulations and laws the status of the above mentioned product could eventually change. If you have any doubt relating to the current correctness of this declaration, please contact us for an update.

**Clariant Plastics & Coatings (Nordic) AB**

**Tine Tornqvist Tosun**  
**Product Stewardship**

This declaration was produced automatically, and therefore does not have an original signature

Clariant Plastics & Coatings (Nordic) AB  
Box 9053  
SE-200 39 Malmö  
Phone: +46 40 671 72 00  
E-mail: [psmalmo@clariant.com](mailto:psmalmo@clariant.com)  
Web: [www.clariant.com](http://www.clariant.com)



The attached declaration has been compiled according the best information available to us, and according to the laws in force at the publication date of the document itself. It is forbidden to, entirely or partially, reproduce the present declaration and to issue it to a third party without written assent of Clariant.

---

## Declaration

---

### REMAFIN-EP-WHITE PL00075542-ZT

#### Introduction

All statements refer exclusively to the named product in its current formulation: they are based on the present state of our knowledge and experience and concern the product in its original form and packaging as supplied from our factory. This certificate cannot be extended to the finished article.

Since the manufacturer has no influence on subsequent processing, the processor himself is responsible for ensuring that the finished article is suitable for the intended use, and is also responsible for ascertaining the compliance of the end article with the national and international regulations and laws concerning its application field.

#### Information for Pharmaceutical and Medical Device Application

##### 1. European Pharmacopoeia

###### Identification:

The plastic carrier of the product is LLDPE.

The product contains TIO<sub>2</sub>. Details can be further disclosed upon request and under a mutual confidentiality agreement.

###### Tests:

All the components of the product were tested according to European Pharmacopoeia 9th edition, chapter 3.1.3 (polyolefins) and Chapter 3.1.5 Polyethylene with Additives for Containers for Parenteral Preparations and for Ophthalmic Preparations, and were confirmed to meet the requirements of the following section tests;

- Appearance of solution; opalescence
- Appearance of solution; color
- Acidity / Alkalinity
- Absorbance
- Reducing substances
- Substances soluble in hexane
- Extractable aluminum



- Extractable titanium
- Extractable zinc
- Extractable chromium
- Extractable vanadium
- Extractable zirconium
- Extractable heavy metals

In addition, the carrier of the product was confirmed to meet the requirements in the following supplementary tests:

- Phenolic antioxidants
- Non phenolic antioxidants
- Amides and stearates

Plastic additives 18 and 22

The supplementary verification of plastic additives 18 and 22 is not conducted as Clariant does not intentionally add those additives to the product composition and has satisfactory declarations from the raw material manufacturers supporting that plastic additives 18 and 22 are not intentionally added in the raw materials which are part of this product.

**2. <USP 661.1> Plastic materials of construction:**

Identification:

The plastic carrier of the product is LLDPE.

All the components of the product were tested and were confirmed to meet the below requirements according to UNITED STATES PHARMACOPOEIA 39 NF 34 AND 40 NF 35; GENERAL CHAPTERS: 661.1, SECTIONS “PHYSICOCHEMICAL TESTS, EXTRACTABLE METALS AND PLASTIC ADDITIVES”

- Absorbance
- Acidity or Alkalinity
- Total Organic Carbon
- Extractable Aluminium
- Extractable Arsenic
- Extractable Cadmium
- Extractable Lead
- Extractable Cobalt
- Extractable Nickel
- Extractable Vanadium
- Extractable Chromium
- Extractable Titanium
- Extractable Zinc
- Extractable Zirconium
- Extractable Mercury
- Plastic additives. Phenolic antioxidants, non-phenolic antioxidants.

Copolymer of dimethyl succinate and (4-hydroxy -2,2,6,6-tetramethylpiperdiidin-1-yl)ethanol

The supplementary verification of Copolymer of dimethyl succinate and (4-hydroxy -2,2,6,6-tetramethylpiperdiidin-1-yl)ethanol is not conducted as Clariant does not intentionally add that additive to the product composition and has satisfactory declarations from the raw material manufacturers supporting that the additive is not intentionally added in the raw materials which are part of this product.

Limiting addition of the product:

Taking into account the content of the different components in the above mentioned product and the concentration in the framework formulation tested, a maximum addition of 5,0 % is recommended.

Others:

The product contains apart from colorants, listed additives that can be disclosed upon request and under a mutual confidentiality agreement.

The reference of compliance with the Indirect Food Additive regulations 21 CFR 174–186 is declared in a separate statement.

Biological Reactivity Tests of all the components of the product (USP <87>, <88>, ISO 10993) are declared in the Biological declaration of the product.

The information given is based on our current knowledge. It should not be construed as a guarantee for specific applications.

**Medical Application Policy**

Clariant products have not been designed for nor are they promoted or intended for use in:

- (a) medical devices categorized by either the United States Food and Drug Administration or the International Standards Organization (ISO) as an “implant” device; or “Permanent” as defined under US Pharmacopoeia (USP) or ISO standards; or
- (b) active implantable medical devices as defined in EU Directive 90/385/EEC as amended; or
- (c) medical devices for “Long Term” use as defined in EU Directive 93/42/EEC as amended.

Without limiting the generality of this statement, Clariant products shall not be used in any medical device application intended for:

- (1) exposure to human tissue or body fluids for 30 days or greater;
- (2) cosmetic or reconstructive use;
- (3) reproductive implants or any birth control device; or
- (4) any critical component in a permanently (greater than 30 days) implanted medical device that supports or sustains human life.

It is the responsibility of the medical device manufacturer and the person placing the medical device on the market to ensure compliance of the medical device, including the suitability of all raw materials and components used for its manufacture, with all applicable laws and regulations.

CLARIANT MAKES NO REPRESENTATION, PROMISE, OR EXPRESS OR IMPLIED WARRANTY CONCERNING THE SUITABILITY OR LAWFULNESS OF CLARIANT'S PRODUCTS FOR USE IN ANY MEDICAL DEVICE UNLESS EXPRESSLY STATED IN A WRITTEN AGREEMENT SIGNED BY A DULY AUTHORIZED CLARIANT REPRESENTATIVE.

If you have any questions or comments, please do not hesitate to contact us for further assistance.

Sincerely,

**Clariant Plastics & Coatings (Nordic) AB**

**Hans Johansson**  
**Product Stewardship**

---

**Declaration:**  
**ICH Q3D Guideline. Elemental Impurities**

---

**REMAFIN-EP-WHITE PL00075542-ZT**

**Introduction**

The ICH Q3D Guideline presents a process to assess and control elemental impurities in a drug product. To assist the drug manufacturer in developing a risk assessment, information on the impact of the raw materials in the above mentioned product, as being a part of a container closure system, is given. The information is provided related to extractable elemental impurities, derived from below declared assumptions and from representative raw material samples. Clariant does not perform routine testing of extractable elemental impurities on batch to batch level.

All statements refer exclusively to the named product in its current formulation: they are based on the present state of our knowledge and experience and concern the product in its original form and packaging as supplied from our factory. This certificate cannot be extended to the finished article.

Since the manufacturer has no influence on subsequent processing, the processor himself is responsible for ensuring that the finished article is suitable for the intended use, and is also responsible for ascertaining the compliance of the end article with the national and international regulations and laws concerning its application field.

**Information for Pharmaceutical and Medical Device Application**

**1. Metal Analysis based on the ICH Q3D Guideline for Elemental Impurities**

Tests:

The components were tested according to United States Pharmacopoeia 40 NF 35, chapter 661.1 "Polyethylene", European Pharmacopoeia 9th edition 2017 (9.2), chapter 3.1.3 "Polyolefins" section "Test Solution S3" and ICH Harmonised Guideline, Guideline for Elemental Impurities Q3D.

Test solution S3

At a ratio of 100g / 250 ml the test material was boiled under reflux conditions in 0,1 M hydrochloric acid during 1 hour under constant stirring. After refluxing the extract was decanted and cooled down to room temperature.

A blank was prepared simultaneously using 0,1 M hydrochloric acid without any test material. Extractable Metals (Cd, Pb, As, Co, V, Ni, Tl, Au, Pd, Ir, Os, Rh, Ru, Se, Ag, Pt, Li, Sb, Ba, Mo, Cu, Sn, Cr)

Extractable Cd, Pb, As, Co, V, Ni, Tl, Au, Pd, Ir, Os, Rh, Ru, Se, Ag, Pt, Li, Sb, Ba, Mo, Cu, Sn and Cr in Test solution S3 and the blank, were determined on a Varian Inductive Coupled Plasma (ICP) – Optical Emission Spectrometer equipped with a SPS 3 auto sampler and a Simultaneous Axial View High Resolution Echelle Polychromator CCD Detector. The blank corrected concentrations of the extractable metals in the Test solution S3 are shown in “Summary of test results”.

<i>Target compound wavelengths</i>			
<b>Element</b>	<b>Wavelength</b>	<b>Element</b>	<b>Wavelength (</b>
Cadmium (Cd)	228.802	Ruthium (Ru)	267.876
Lead (Pb)	220.353	Selenium (Se)	196.026
Arsenic (As)	188.980	Silver (Ag)	328.068
Cobalt (Co)	231.160	Platinum (Pt)	214.424
Vanadium (V)	311.837	Lithium (Li)	670.783
Nickel (Ni)	227.021	Antimony (Sb)	206.834
Thallium (Tl)	190.794	Barium (Ba)	455.403
Gold (Au)	242.794	Molybdenum (Mo)	204.598
Palladium (Pd)	340.458	Copper (Cu)	327.395
Iridium (Ir)	212.681	Tin (Sn)	189.925
Osmium (Os)	225.585	Chromium (Cr)	267.716
Rhodium (Rh)	343.488		

Table 1: Wavelengths

Mercury (ICP/MS)

Extractable Hg in Test solution S3 and the blank, was determined on a Perkin Elmer NexION 300x Inductive Coupled Plasma Spectrometer. The extractable Hg in Test solution is shown in “Summary of test results”.

<b>Metal</b>	<b>Main Mass Hg</b>
Mercury (Hg)	201.971

Table 2: Main Mass of Mercury

Summary of test results

Element	Class	LOD µg/L	LOQ µg/L	Results µg/L
Cadmium (Cd)	1	1	2	< 1
Lead (Pb)	1	3	5	< 3
Arsenic (As)	1	6	10	< 6
Mercury (Hg)	1	N/A	0.5	< 0.5
Cobalt (Co)	2A	0.5	1	< 0.5
Vanadium (V)	2A	2	5	< 2
Nickel (Ni)	2A	2	5	< 5
Thallium (Tl)	2B	5	10	< 5
Gold (Au)	2B	10	20	< 10
Palladium (Pd)	2B	26	51	< 26
Iridium (Ir)	2B	10	20	< 10
Osmium (Os)	2B	2	5	< 2
Rhodium (Rh)	2B	2	5	< 2
Ruthium (Ru)	2B	2	5	< 2
Selenium (Se)	2B	9	26	< 9
Silver (Ag)	2B	1	3	< 1
Platinum (Pt)	2B	4	10	< 4
Lithium (Li)	3	0.5	1	< 0.5
Antimony (Sb)	3	2	5	< 2
Barium (Ba)	3	1	2	< 2
Molybdenum (Mo)	3	2	5	< 2
Copper (Cu)	3	2	5	< 2
Tin (Sn)	3	9	21	< 9
Chromium (Cr)	3	1	2	< 3

Table 3: Limit of detection (LOD), limit of quantification (LOQ) of elements analyzed by ICP/OES and ICP/MS (Hg), results (µg/L).

Limiting addition of the product:

Taking into account the content of the different components in the above mentioned product and the concentration in the framework formulation tested, a maximum addition of 5,0 % is recommended.

Change Control:

The declared test results are derived from representative raw material samples. For the Mevopur and Remafin EP range of products, Clariant Plastics & Coatings operates under change control principles for the raw materials and related product manufacturing and under a third party certified Quality Management System according to ISO 13485. Potential variations, coming from raw material supplier composition and processes, beyond their specifications and ability for them and/or Clariant Plastics & Coatings to control, cannot be excluded.

Others:

The information given is based on our current knowledge. It should not be construed as a guarantee for specific applications.

**Medical Application Policy**

Clariant products have not been designed for nor are they promoted or intended for use in:

- (a) medical devices categorized by either the United States Food and Drug Administration or the International Standards Organization (ISO) as an “implant” device; or “Permanent” as defined under US Pharmacopoeia (USP) or ISO standards; or
- (b) active implantable medical devices as defined in EU Directive 90/385/EEC as amended; or
- (c) medical devices for “Long Term” use as defined in EU Directive 93/42/EEC as amended.

Without limiting the generality of this statement, Clariant products shall not be used in any medical device application intended for:

- (1) exposure to human tissue or body fluids for 30 days or greater;
- (2) cosmetic or reconstructive use;
- (3) reproductive implants or any birth control device; or
- (4) any critical component in a permanently (greater than 30 days) implanted medical device that supports or sustains human life.

It is the responsibility of the medical device manufacturer and the person placing the medical device on the market to ensure compliance of the medical device, including the suitability of all raw materials and components used for its manufacture, with all applicable laws and regulations.

CLARIANT MAKES NO REPRESENTATION, PROMISE, OR EXPRESS OR IMPLIED WARRANTY CONCERNING THE SUITABILITY OR LAWFULNESS OF CLARIANT’S PRODUCTS FOR USE IN ANY MEDICAL DEVICE UNLESS EXPRESSLY STATED IN A WRITTEN AGREEMENT SIGNED BY A DULY AUTHORIZED CLARIANT REPRESENTATIVE.

If you have any questions or comments, please do not hesitate to contact us for further assistance.

Sincerely,

**Clariant Plastics & Coatings (Nordic) AB**

**Hans Johansson**  
**Product Stewardship**

Katarzyna Jawor  
Gerresheimer Boleslawiec S.A

PL -  
Poland

32547357

07.11.2019

---

## Declaration

---

### REMAFIN-EP-WHITE PL00075542-ZT

#### Introduction

All statements refer exclusively to the named product in its current formulation: they are based on the present state of our knowledge and experience and concern the product in its original form and packaging as supplied from our factory.

Since the masterbatch and compound manufacturer has no influence on subsequent processing, the processor himself is responsible for ensuring that the finished article is suitable for the intended use, and is also responsible for ascertaining the compliance of the end article with the national and international regulations and laws concerning its application field.

#### Additional information

- Based on the current formulation of the above mentioned product, the following substances have not been intentionally added during its production:

Nitrosamines

These substances were not used as starting materials during the mixing phase of our product but, on the basis of our current knowledge, we cannot give you any warranty they are not constitutionally contained (or are present at level of ubiquitous(\*\*) traces) in raw materials. Please note that, in any case our Company does not carry out any specific analysis in order to detect the presence of above mentioned substances.

(\*\*)Ubiquitous in regard to a chemical substance means that this substance is omnipresent (occurs literally everywhere) and its occurrence in this "ubiquitous" traces cannot be avoided by any technical, physical or chemical measure.

#### Additional information

In addition be informed that, in case here above was not clearly mentioned, you can find the following information into the Safety Data Sheet you already got by us:

- the ingredients that may be classified as dangerous for health and environment;
- information on restriction on use that we are aware of and that could be relevant for plastic applications.



## Clariant Plastics & Coatings (Nordic) AB

### Country Product Stewardship

This declaration was produced automatically and therefore does not have an original signature

This information corresponds to the present state of our knowledge and is intended as a general description of our products and their possible applications. Clariant makes no warranties, express or implied, as to the information's accuracy, adequacy, sufficiency or freedom from defect and assumes no liability in connection with any use of this information. Any user of this product is responsible for determining the suitability of Clariant's products for its particular application. Nothing included in this information waives any of Clariant's General Terms and Conditions of Sale, which control unless it agrees otherwise in writing. Any existing intellectual/industrial property rights must be observed. Due to possible changes in our products and applicable national and international regulations and laws, the status of our products could change. Material Safety Data Sheets providing safety precautions, that should be observed when handling or storing Clariant products, are available upon request and are provided in compliance with applicable law. You should obtain and review the applicable Material Safety Data Sheet information before handling any of these products. For additional information, please contact Clariant.

\* For sales to customers located within the United States and Canada the following applies in addition:  
NO EXPRESS OR IMPLIED WARRANTY IS MADE OF THE MERCHANTABILITY, SUITABILITY, FITNESS FOR A PARTICULAR PURPOSE OR OTHERWISE OF ANY PRODUCT OR SERVICE.

9/2010

# Test report

Report No  
829168/8



DANISH  
TECHNOLOGICAL  
INSTITUTE

Gregersensvej  
DK-2630 Taastrup  
Telephone +45 72 20 20 00  
Telefax +45 72 20 20 19

info@teknologisk.dk  
www.teknologisk.dk

19 December 2018  
Page 1 of 2  
KKJ/HEAL/bbi

**Client:** Gerresheimer Vaerloese  
Walgerholm 2-8  
3500 Vaerloese  
Denmark

**Subject:** Closure: Duma Handy Cap, 009022-4000  
Container: Duma Standard 2500 ml, 952500-4000

**Sampling:** Date of receipt: 12 September 2018

**Test Period:** 5 December 2018 – 19 December 2018

**Test requirements:** Classification: Moisture Vapour Transmission – see page two for description

**Test performed by:** Test responsible Karina Kjeldgaard-Nielsen, Product Manager

**Results:** mg water vapour per day per litre container-volume:

No 01	No 02	No 03	No 04	No 05	No 06	No 07	No 08	No 09	No 10
4.8	4.8	4.0	4.0	3.5	4.3	4.3	3.5	3.0	3.2

Average: 3.9 mg/d/l

## Conclusion

The tested containers comply with the classification of USP 41 <671> test for *tight containers*.

**Remarks:** Req. no. 12919

**Terms:** The test has been performed according to the conditions laid down by the general terms and conditions of The Danish Technological Institute. The test results apply to the tested products only. This test report may be reproduced in extract only if the Laboratory has approved the extract in writing.

**Test place:** Technological Institute, Taastrup, Plastics and Packaging Technology

**Signature:**

Karina Kjeldgaard-Nielsen,  
Product manager  
Phone: +45 7220 1752  
kkj@teknologisk.dk

Test responsible, signatory

Helle Allermann,  
Senior Consultant  
Phone: +45 7220 3163  
heal@teknologisk.dk

Co-reader

**Description test subjects:**Container

Type: Duma Standard 2500 ml  
Number: 952500-4000  
Raw material: GF4760 (PE-HD)  
Colour: White, PL00075542-ZT (PE)  
Cavity: 1 (mould 1)

Closure

Type: Duma Handy Cap  
Number: 009022-4000  
Raw material: LD 653 (PE-LD)  
Colour: White, 21156601 (PE)  
Cavity: 1-4 (mould 1)

**Method:** Classification Systems for Plastic Packaging Systems. Classification Based on Desiccant Method 4.

**Classification of Moisture Vapour Transmission:**

10 specimens of containers and closures have been tested according to USP 41 <671>. Packaging systems are "tight" if not more than 1 of the 10 test containers exceeds 100 mg/day/L in moisture vapor transmission, and none exceeds 200 mg/day/L. Packaging are well-closed if not more than 1 of the 10 test containers exceeds 2000 mg/day/L in moisture vapor transmission, and none exceeds 3000 mg/day/L.

# Test report

Report No  
890943/03



DANISH  
TECHNOLOGICAL  
INSTITUTE

Gregersensvej  
DK-2630 Taastrup  
Telephone +45 72 20 20 00  
Telefax +45 72 20 20 19

info@teknologisk.dk  
www.teknologisk.dk

25 September 2019  
Page 1 of 1  
HEAL/bbi  
Enclosures: 1

**Client:** Gerresheimer Vaerloese  
Walgerholm 2-8  
3500 Vaerloese  
Denmark

**Subject:** Container  
Type: Duma Standard 2500 ml  
Number: 952500-4000  
Raw material: GF4760 (PE-HD)  
Colour: White, PL00075542-ZT (PE)  
Cavity: 1 (mould 1)

**Sampling:** Date of receipt: 20 September 2019.

**Test Period:** 24 September 2019.

**Test requirements:** **Light Transmission**  
Samples from the container have been tested according to USP 42 <671>.  
Requirement: The light transmission must not exceed 10 % in the range from 290 to 450 nm. Enclosure 1 shows the spectra from 290 to 450 nm of the samples from the container.

**Test performed by:** Test responsible: Helle Allermann, Senior Consultant

**Results:** maximum % light transmission:

Sample No 1	Sample No 2
6.0	5.9

**Conclusion**

The tested container complies with the requirement of USP 42 <671>.

**Terms:** The test has been performed according to the conditions laid down by the general terms and conditions of The Danish Technological Institute. The test results apply to the tested products only. This test report may be reproduced in extract only if the Laboratory has approved the extract in writing.

**Test place:** Technological Institute, Plastics and Packaging Technology

**Signature:**

Helle Allermann,  
Senior Consultant  
Mobile: +45 72 20 31 63  
heal@dti.dk  
Test responsible, signatory

Alexander Bardenshtein,  
Product Manager  
Mobile: +45 72 20 22 38  
alb@dti.dk  
Co-reader

**Gerresheimer Vaerloese**

Type: Duma Standard 2500 ml

Number: 952500-4000

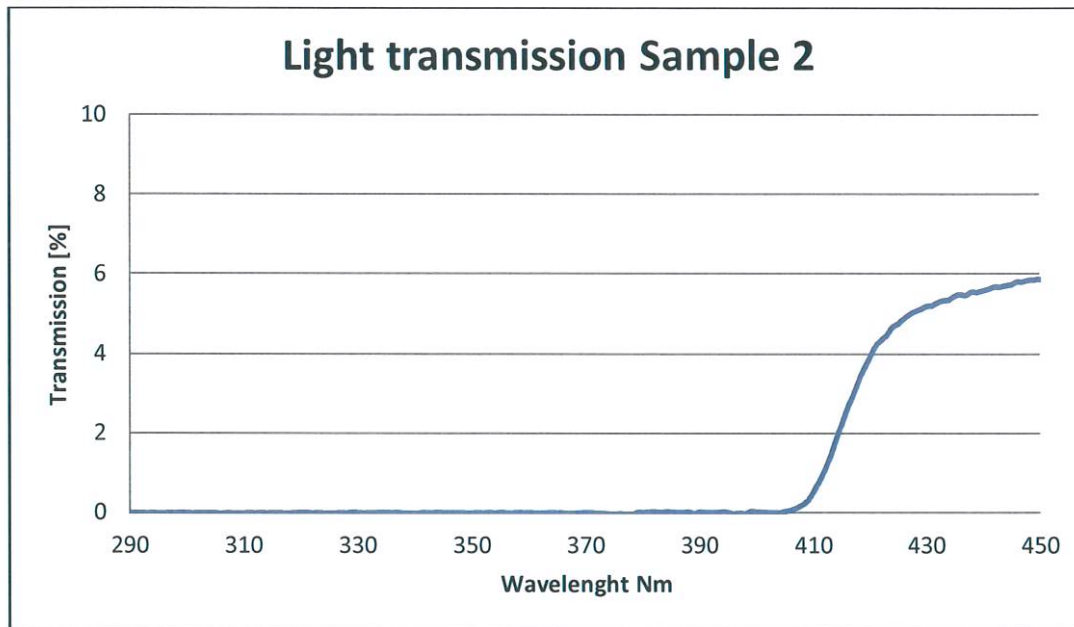
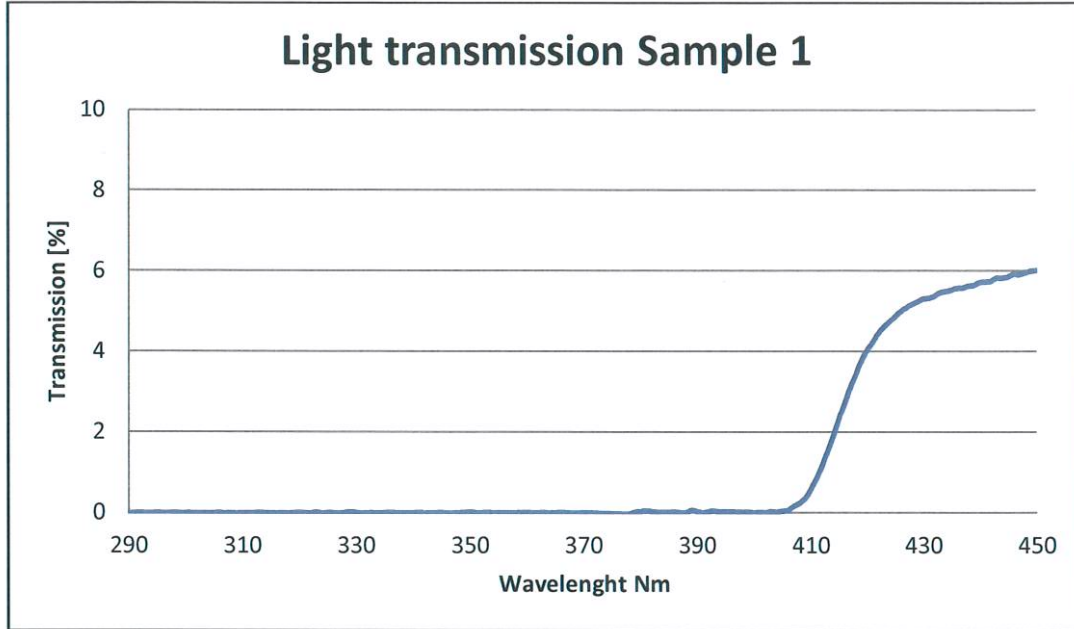

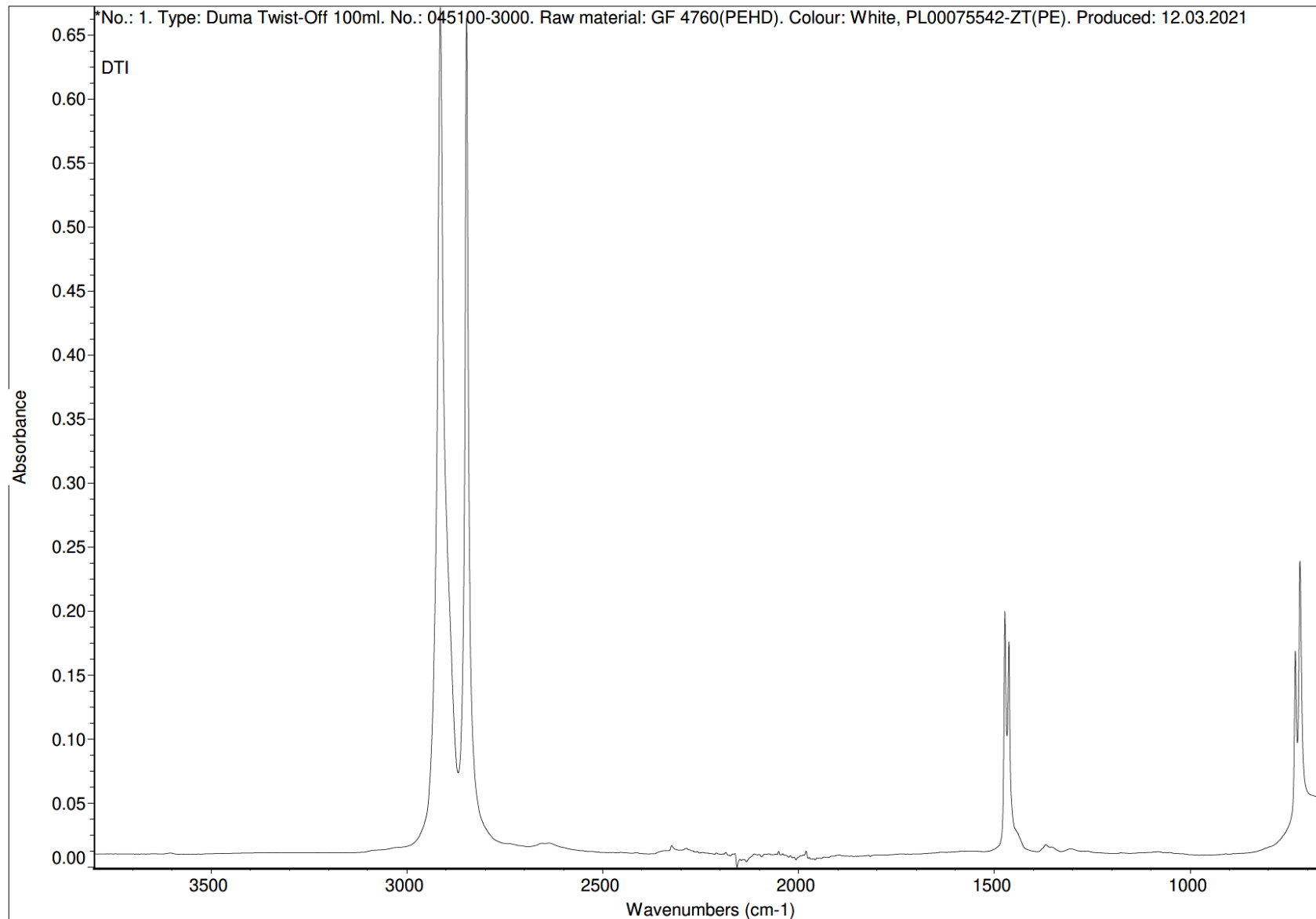



## Test report

### Customer

Gerresheimer Vaerloese A/S  
Walgerholm 2-8  
DK-3500 VaerloeseRep. no.: 139/16-2  
Page: 1 of 2  
No. of encl.: 1  
Cosign: *Ten*

### Test

Thermal analysis

### Sample

Raw material sent to our laboratory on 22 June 2016 bearing the following ID

DSC sample no. 1  
Raw material: GF 4760 (HDPE)  
Batch no.: SD 1042201DSC sample no. 6  
Raw material: GB 7250 (HDPE)  
Batch no.: SC 2942101

### Test method

The DSC (thermal analysis) is based on

USP 39 <661> *Containers - Plastics / Physical Tests*, which refers to  
USP 39 <891> *Thermal Analysis*One spot sample (approx. 12 mg) was taken from the raw material.  
The following conditions were used for the comparative DSC analysis:Heating 40 °C to +200 °C at 10 °C/min in nitrogen (80 ml/min)  
Cooling 200 °C to 40 °C at 10°C/min in nitrogen (80 ml/min)

The peak values of the Onset temperature are compared.



## Test equipment

32T07.02	Calorimeter, Differential Scanning Calorimetry, DSC 823e from Mettler-Toledo
32T14.60	Analytical balance XS 105 from Mettler-Toledo
32T07.03	Reference sample of High density polyethylene from USP (Rockville)
Purge gas	Nitrogen (purity grading: 5) from Aga

## Test results

Sample	Melting Peak °C	Onset °C	Difference between values (Onset temperature) °C
Ref sample of high density polyethylene	136.3	124.8	-
DSC sample no. 1 Raw material: GF 4760 (HDPE) Batch no.: SD 1042201	133.4	122.8	2.0
DSC sample no. 6 Raw material: GB 7250 (HDPE) Batch no.: SC 2942101	128.7	121.7	3.1

Acceptance criteria: Difference between values (Onset temperature)  $\leq 6.0$  °C

Test result: *Pass*

Rev. 1: The report has been revised because the ID of the samples in the results has been changed.

Yours sincerely  
Centre for Plastics Technology



Tina Elmer Nielsen  
Laboratory Technician

Phone: +45 72 20 31 13 (direct)  
Email: ten@teknologisk.dk

Conditions: The test results are solely referring to the tested (examined) materials. The testing has been performed in compliance with an accreditation from the Danish Accreditation Scheme.  
Enclosed are the General Terms and Conditions regarding Commissioned Work accepted by the Danish Technological Institute (DTI)  
Publication of the Test Report in full is allowed. Publication of extracts from the Test Report is allowed, if the testing laboratory has given a written approval.



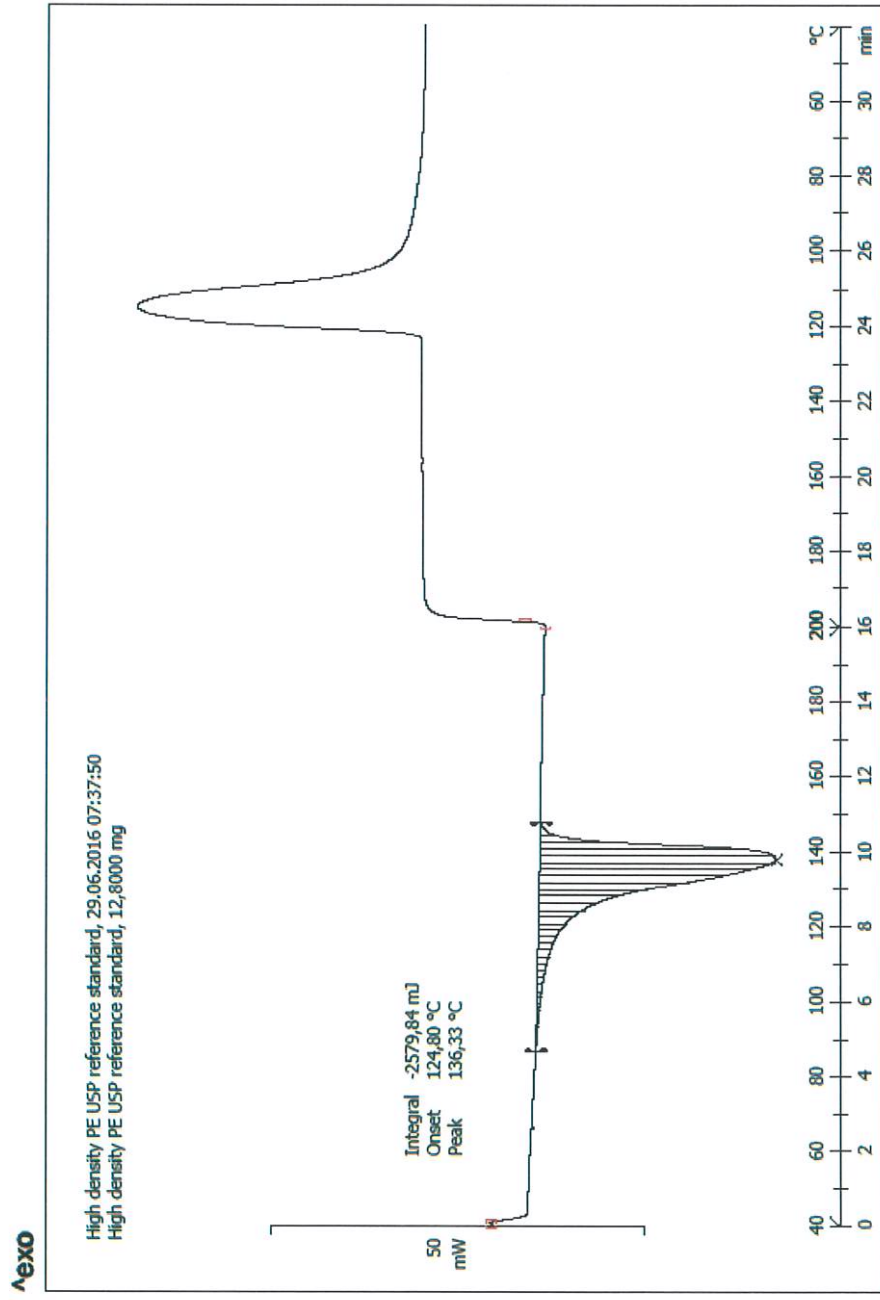

**STAR® SW 11.00**

**Lab: Plastteknologi**

Ref sample of High-density polyethylene

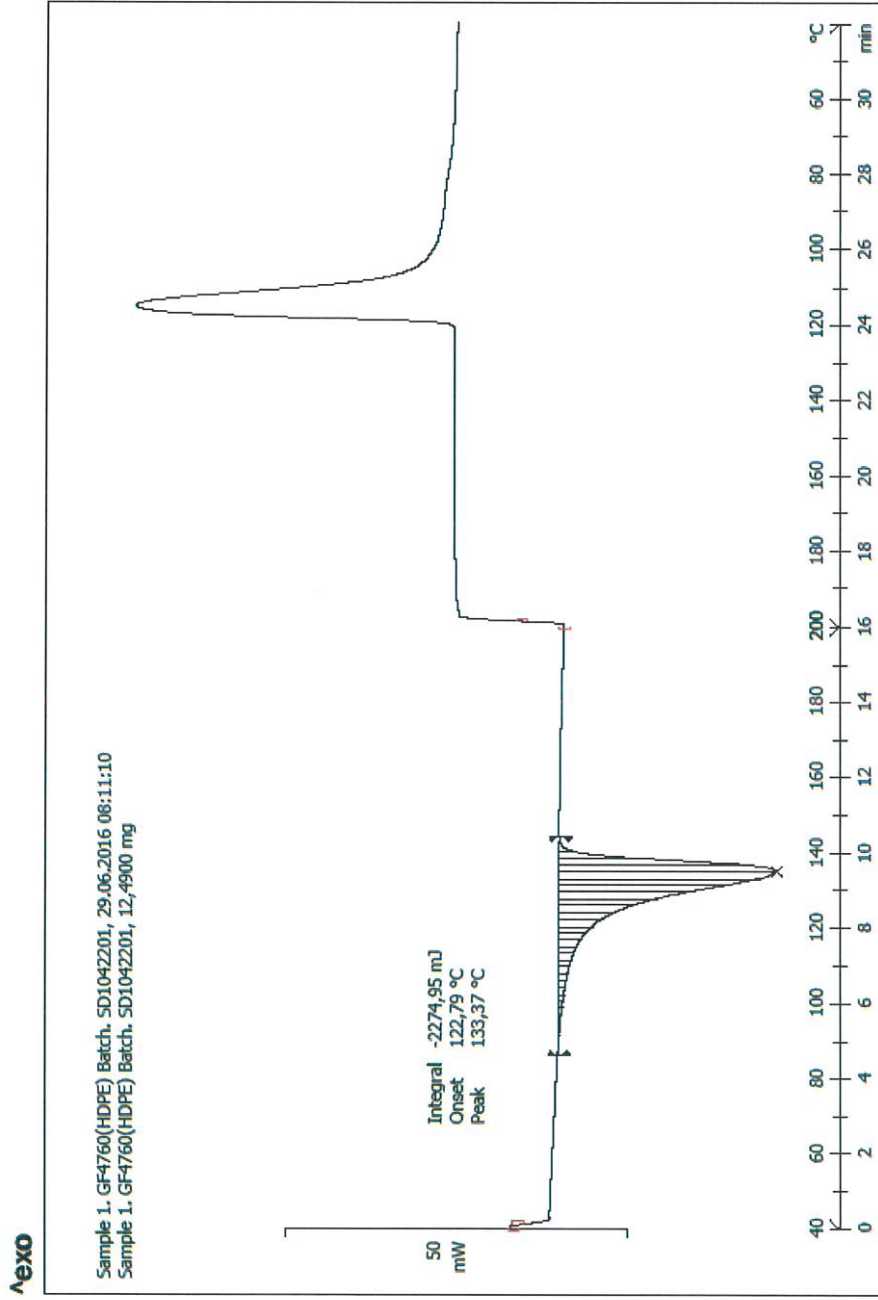

Lab: Plastteknologi

DSC sample no. 1  
Raw material: GF 4760 (HDPE)  
Batch no.: SD 1042201

exo

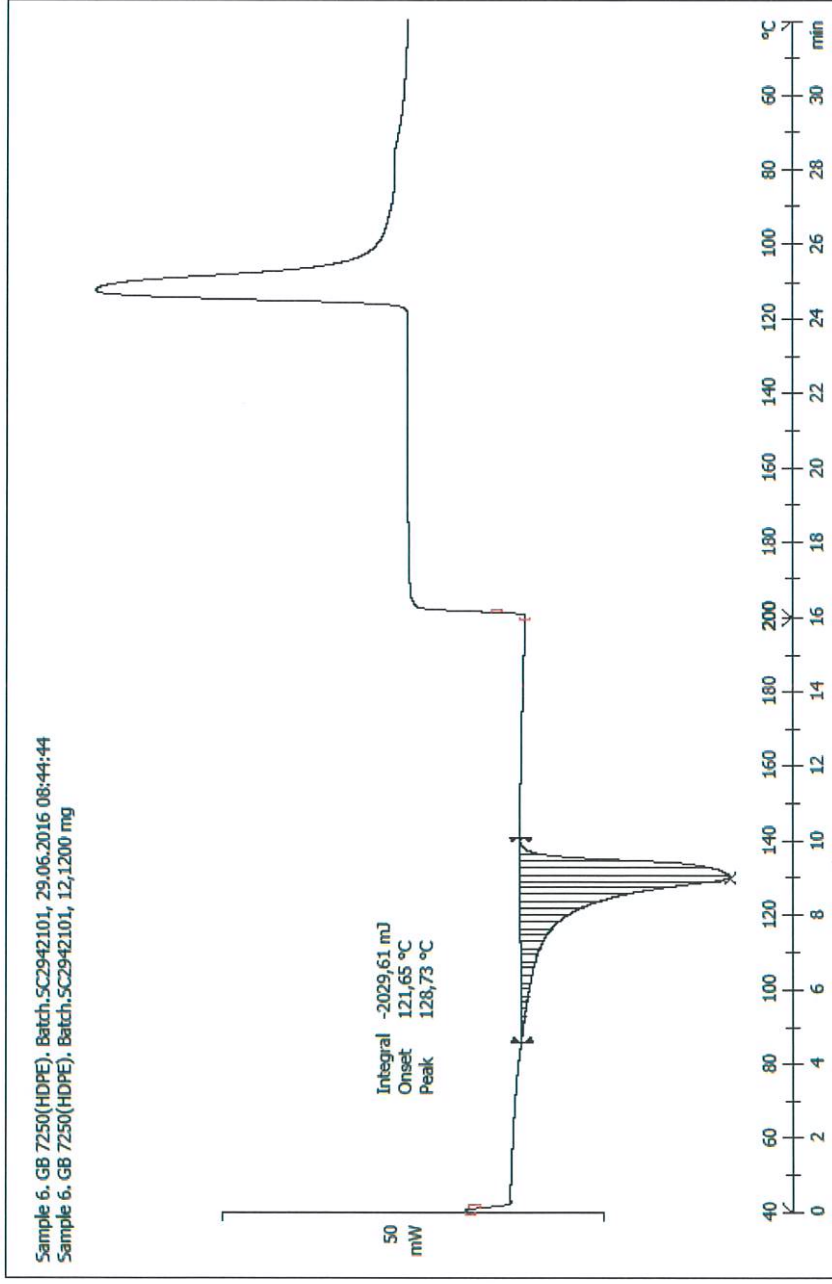

Lab: Plastteknologi

STAR<sup>®</sup> SW 11.00

DSC sample no. 6  
Raw material: GB 7250 (HDPE)  
Batch no.: SC 2942101

## TEST RESULT REPORT

**TE202033/ 20-B9815**

Material: Duma Container (100 mL) with Handy Cap

Lot: GF4760 + LD653 + PEZ121818X

**TESTS ON PLASTIC PACKAGING SYSTEMS FOR PHARMACEUTICAL USE -  
USP 43 NF 38**

**CHAPTER: 661.2**

Client: Gerresheimer Vaerloese A/S

Contact: Mr. René Palmelund

Address: Walgerholm 2-8

3500 Vaerloese

Denmark

Client Purchase Order Number: 15191

Quotation Number: 2004165

Date Receipt Samples: 06 Jul 2020

Date Start Analysis: 23 Jul 2020

Date Technical Release: 30 Jul 2020

Date Final Test Result Report: 14 Aug 2020

### REFERENCES:

United States Pharmacopoeia 43 NF 38, Chapter 661.2 section "Physicochemical Tests".



Iris Persy  
Study Director



Stijn Nulens, Ing.  
Quality Assurance Unit

**RESULTS:**

The results are presented in Table 1.

*Table 1: Results of Analysis*

<b>Test</b>	<b>Results</b>	<b>Evaluation Criteria</b>	<b>Meets Criteria</b>
Appearance of Solution C1	Clear, no color	Solution C1 is clear and colorless	PASS
Absorbance	$\leq 0.20$ A.u.	Maximum Absorbance between 230 nm to 360 nm $\leq 0.20$ A.u.	Meets Specification
Acidity	+ 0.4 mL 0.01N NaOH → colorless to pink	$\leq 0.4$ mL of 0.01N NaOH → colorless to pink	PASS
Alkalinity	+ 0.8 mL 0.01 N HCl → pink to orange-red	$\leq 0.8$ mL of 0.01N HCl → pink to orange-red	PASS
TOC	$\leq 8$ mg/L	Maximum difference between sample and blank TOC $\leq 8$ mg/L	Meets Specification

**CONCLUSION:**

Based on the evaluation criteria mentioned above, the test material *complies with the limits* of the United States Pharmacopoeia 43 NF 38, Chapter 661.2 section “Physicochemical Tests”, *and meets the specifications* for “Absorbance” and “TOC”.

## TEST RESULT REPORT

**TE202033/ 20-B9816**

Material: Duma Container (750 mL) with Handy Cap

Lot: GF4760 + LD653 + 21156601

**TESTS ON PLASTIC PACKAGING SYSTEMS FOR PHARMACEUTICAL USE -  
USP 43 NF 38**

**CHAPTER: 661.2**

Client: Gerresheimer Vaerloese A/S

Contact: Mr. René Palmelund

Address: Walgerholm 2-8

3500 Vaerloese

Denmark

Client Purchase Order Number: 15191

Quotation Number: 2004165

Date Receipt Samples: 06 Jul 2020

Date Start Analysis: 23 Jul 2020

Date Technical Release: 30 Jul 2020

Date Final Test Result Report: 14 Aug 2020

### REFERENCES:

United States Pharmacopoeia 43 NF 38, Chapter 661.2 section "Physicochemical Tests".



Iris Persy  
Study Director



Stijn Nulens, Ing.  
Quality Assurance Unit

**RESULTS:**

The results are presented in Table 1.

*Table 1: Results of Analysis*

Test	Results	Evaluation Criteria	Meets Criteria
Appearance of Solution C1	Clear, no color	Solution C1 is clear and colorless	PASS
Absorbance	$\leq 0.20$ A.u.	Maximum Absorbance between 230 nm to 360 nm $\leq 0.20$ A.u.	Meets Specification
Acidity	+ 0.4 mL 0.01N NaOH → colorless to pink	$\leq 0.4$ mL of 0.01N NaOH → colorless to pink	PASS
Alkalinity	+ 0.8 mL 0.01 N HCl → pink to orange-red	$\leq 0.8$ mL of 0.01N HCl → pink to orange-red	PASS
TOC	$\leq 8$ mg/L	Maximum difference between sample and blank TOC $\leq 8$ mg/L	Meets Specification

**CONCLUSION:**

Based on the evaluation criteria mentioned above, the test material *complies with the limits* of the United States Pharmacopoeia 43 NF 38, Chapter 661.2 section “Physicochemical Tests”, *and meets the specifications* for “Absorbance” and “TOC”.



## TEST RESULT REPORT: 16-B3696-N1

<b>Project Number:</b>	<b>TE161161</b>	<b>Report Date:</b>	<b>30/06/2016</b>
<b>Sponsor:</b>	<b>Gerresheimer Vaerloese A/S</b>		
<b>Contact Person:</b>	<i>René Palmelund</i>		
<b>Address:</b>	Walgerholm 2-8	<b>Date Sample Arrival:</b>	15/06/2016
<b>City, State, Zip:</b>	3500 Vaerloese	<b>Technical Initiation:</b>	27/06/2016
<b>Country:</b>	Denmark	<b>Technical Completion:</b>	30/06/2016

<b>Study:</b>	<b>Qualitative MEM-elution: Dye exclusion</b>	<b>Temp/Time</b>	37°C/24 hours
<b>Test article name:</b>	<b>042150-3000</b>	<b>Ratio</b>	4g/20mL
<b>Lot number:</b>	<b>Sample 3</b>	<b>Vehicle</b>	MEM-Complete

**REFERENCE:** According to "ISO 10993-5, 2009: Biological Evaluation of Medical Devices- Part 5:Tests for In Vitro Cytotoxicity." and "USP 39-NF 34, 2016: <87> Biological reactivity test, in vitro." Toxikon Reference: SOP 3.1.2.3, rev. 10

**PROCEDURE:** The biological reactivity of a mammalian monolayer, L929 mouse fibroblast cell culture, in response to the test item extract was determined. The control articles were autoclaved prior to the preparation of the extracts. Extracts were prepared at 37±1°C for 24±2 hours in a humidified atmosphere containing 5±1% carbon dioxide (static). Positive (natural rubber) and negative (silicone) control articles were prepared to verify the proper functioning of the test system. The test item extract was sterile filtered. The maintenance medium on the cell cultures is replaced by the extracts of the test item or control article in triplicate and the cultures are subsequently incubated for 2 days, at 37±1°C, in a humidified atmosphere containing 5±1% carbon dioxide. Biological reactivity was rated on the following scale: Grade 0 (No reactivity); Grade 1 (Slight reactivity), Grade 2 (Mild reactivity), Grade 3 (Moderate reactivity) and Grade 4 (Severe reactivity). The test item is considered to have no cytotoxic potential if none of the cultures exposed to the test item shows greater than mild reactivity (Grade 2).

**RESULTS:** No reactivity (Grade 0) was exhibited by the cell cultures exposed to the test item at the 2 days observation. Severe reactivity (Grade 4) was observed for the positive control article. The negative control article showed no signs of reactivity (Grade 0).

**OPINION AND INTERPRETATION:** Based on the evaluation criteria mentioned above, the test item is considered to have no cytotoxic potential.

**RECORD STORAGE:** All raw data generated in this study will be archived at Toxikon Europe, according to SOP 4.2.8.

**AUTHORIZED PERSONNEL**

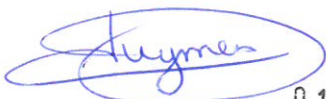

01 JUL 2016  
Ms. Vanessa Ruymen  
Study Director



04 JUL 2016  
Ms. Anja De Schouwer  
Quality Assurance

The test results on the enclosed report are only referring to the tested articles. Partly reproduction of this report can only be allowed after written permission of Toxikon. Toxikon guarantees that all results are acquired by testing according to officially accepted scientific methodology.



# Quality Control

The quality assurance system of Primary Packaging Plastics is oriented towards a “zero defect strategy”. AQL values for dimensions must be within agreed specified limits. The necessary safety with respect to avoidance of dimensions out of specification (OOS) is achieved by means of process validation including risk analysis and/or in-line measurements and/or measurements on samples.

AQL values are defined on attributive characteristics according to below classification.

## Classification of defects

Classification of defect	Effects of defects	Defect class	AQL		Consequence
			Containers	Caps	
Critical	<p>Critical defects are defects whose presence can have critical consequences. They can, for example:</p> <ul style="list-style-type: none"> <li>• endanger human life or health</li> <li>• or violate legal requirements</li> <li>• or lead to destruction or alteration of filling material</li> <li>• or seriously impair the reliability of storage</li> <li>• or seriously impair the efficiency of production tools, filling and packaging equipment</li> </ul>	1	(*)	(*)	Packaging material not usable
Major	<p>Major defects are defects whose presence can lead to considerable impairment. They can, for example:</p> <ul style="list-style-type: none"> <li>• lead to inefficient function and thus to deficiency of the packaging material/pack</li> <li>• or lead to consumer complaint</li> <li>• or lead to reduced efficiency in production</li> <li>• or impair the efficiency of production tools, and filling and packaging equipment</li> </ul>	2A	0.25	0.1	Usability of packaging material markedly impaired
		2B	1.0	0.4	Usability of packaging material moderately impaired
Minor	<p>Minor defects are defects whose presence do not have essential consequences, for instance they</p> <ul style="list-style-type: none"> <li>• represent a reduction in general quality</li> </ul>	3	4.0	2.5	Usability of packaging material slightly impaired
		4	6.5	-	Usability of packaging material slightly impaired

(\*) No AQL value is defined for defect class 1 since for this defect class, tests are done against zero defects with the greatest possible certainty and/or manufacturing process is to be correspondingly validated. The necessary safety with respect to the avoidance of critical defects class 1 is achieved by means of process validation measures including risk analysis and/or in-line inspection and system checks. If defects of class 1 are found, it must be determined whether the entire batch or part of the batch is affected.

If a partial quantity containing a critical, major or minor defect can be clearly and reliably separated, the quality of the remainder of the batch must be evaluated separately.

## AQL values for EBM containers with re-processed material

Defects	Defect class
<ul style="list-style-type: none"> <li>- Raw material, primary packaging or labelling not according to specification</li> <li>- Mix-up</li> <li>- CFU exceeds specification</li> <li>- Shelf life exceeded</li> <li>- Moisture vapour transmission or light transmission or single internal reflectance or physicochemical OOS according to USP (white products only)</li> <li>- Migration testing exceeds requirements for food contact material (white products only)</li> <li>- Contamination inside, contamination outside - can get into content</li> <li>- Tears, clefts, holes, incompletely moulded - function or tightness not ensured.</li> <li>- Defects on sealing points - tightness impaired</li> <li>- Engraved/embossed text is missing or incorrect</li> <li>- Top and bottom waste</li> </ul>	1
<ul style="list-style-type: none"> <li>- Foreign bodies incorporated in the material</li> <li>- Contamination outside on product - cannot get into content</li> <li>- Inhomogeneous colour</li> <li>- Deformation, not fully moulded, inhomogeneous distribution of material - usability markedly impaired</li> <li>- Flashes - usability markedly impaired</li> <li>- Wall thickness outside specifications</li> <li>- Black spots/degraded material <math>\leq 2</math> spots per container more than <math>&gt; 0.5</math> mm</li> <li>- Uneven surface</li> <li>- Bag with holes or incompletely welded</li> </ul>	2A
<ul style="list-style-type: none"> <li>- Defects on sealing points - tightness not impaired</li> <li>- Flashes - usability moderately impaired</li> <li>- Black spots/degraded material <math>\leq 2</math> spots per container</li> <li>- Black stripes in split line and bottom</li> <li>- Notches, clefts and roughness</li> </ul>	2B
<ul style="list-style-type: none"> <li>- Deformation - usability slightly impaired</li> </ul>	3
<ul style="list-style-type: none"> <li>- Black spots/degraded material <math>\leq 1</math> mm</li> </ul>	4

*If a carton is damaged or soiled upon arrival, the error must be noted at arrival on the shipping documents and the carton discarded. The remaining part of the batch is to be received as normal goods.*

## Quality control for EBM containers with re-processed material

Activity	Control
Incoming control of raw materials	Identification of goods received and control of certificates.
Set-up new mould or change of raw materials or control specification	<b>Line clearance</b> including control of correct use of raw materials. One sample of each cavity produced at the same time is visually controlled as well as checked for critical dimensions with plug-and ring gauges by production and QC prior to production start.
Production	<p>QC operator performs a <b>visual control</b> of the products in accordance with ISO 2859-1. The samples are taken every hour (one sample per cavity produced at the same time). A sample of each cavity is checked for critical dimensions with plug-and ring gauges every second hour.</p> <p>New approval by production and QC is required after <b>machine stops</b> lasting more than one hour.</p> <p>In case of unplanned machine stops where products can be defected the products are 100% controlled or scrapped.</p> <p>If defects are detected, products are quarantine stored or 100% controlled.</p>
Quality control	<p>QC <b>reviews all the production documentation</b> and point out products that need additional control. This also includes follow-up on products which are quarantine stored by production.</p> <p>QC <b>controls the dimensions</b> of the samples from two of the in-process controls with plug-and ring gauges.</p> <p>QC controls the pallets for mix-up and incorrect labelling, releases the products and issue certificates with the results of the controls.</p>

# Declaration of Conformity

## European Pharmacopoeia (EP)

Declaration concerns all products manufactured in Gerresheimer Vaerloese A/S with the following composition:

- **Purell GF 4760 & Remafin EP White PL00075542-ZT**

Based upon certificates from our suppliers of the above mentioned raw materials, Gerresheimer Vaerloese A/S hereby states that the resin and masterbatch comply with the European Pharmacopoeia, paragraphs 3.1.3 "Polyolefines" and 3.1.5 "Polyethylene with additives for containers for preparations for parenteral use and for ophthalmic preparations".

Gerresheimer Vaerloese A/S additionally informs that our packages dedicated for solid oral dosage forms and solid active substances are tested in accordance with food law. For such substances, it has been agreed by the Joint Committee for Medicinal Products for Human Use / Committee for Medicinal Products for Veterinary Use Quality Working Party that plastic materials compliant with the relevant European Union (EU) food legislation relating to plastic materials and articles intended to come into contact with foodstuffs are considered acceptable

Yours sincerely,



Marta Slocka-Momotiuk  
Compliance Specialist

Primary Packaging Plastics

# DECLARATION OF CONFORMITY

**Gerresheimer Vaerloese A/S  
Walgerholm 2-8  
3500 Værløse, Denmark**

## **European Union (EU) Food Contact**

Based upon the certificates from our suppliers of resin and masterbatch, product tests and our certified Quality system, Gerresheimer Vaerloese A/S hereby confirms that the below listed products comply with relevant requirements of Regulation (EC) No 1935/2004 (Framework Regulation) on materials and articles intended to come into contact with food, Regulation (EC) No 2023/2006 on good manufacturing practice for materials and articles intended to come into contact with food and Regulation (EU) No 10/2011 on plastic materials and articles intended to come into contact with food as amended inclusive Regulation (EU) 2019/1338.

- **Duma Twist-Off Containers – White coloured products**
- **Duma MG Containers – White coloured products**
- **Duma Standard Containers – White coloured products**
- **Duma Special Containers – White coloured products**
- **Duma Seal Containers – White coloured products**
- **Dudek Containers – White coloured products**

The intended use for the above listed products is storage of medicine and foodstuff as powder and tablets without fatty surface according to the product specification. Shelf life is 5 years.

The products have been tested for contact with dry food to long time storing at room temperature.

A functional barrier made from plastic is not used in the above mentioned products.

In contrast to specific migration testing where volatile migrants adsorbed onto simulant E can be analysed specifically without losing them, for overall migration testing a gravimetric determination is applied to the extract of simulant E with the consequence that migrants previously adsorbed to simulant E are largely lost again during evaporation of the solvent. Therefore foods, for which only simulant E is prescribed by the Regulation, are not subject to overall migration limit testing.

---

When used as specified, tests have shown that the specific migration does not exceed the legal limits.

The formulation of the raw materials used for the production of the concerned products contains the below listed substances considered to be a dual-use substance according to Regulation (EU) No 10/2011:

- E 470a Calcium salts of fatty acids
- FCM No 610 Titanium dioxide
- FCM No 575 Polydimethylsiloxane

The products contain components with Specific Migration Limits:

- |                     |   |               |
|---------------------|---|---------------|
| • Cas no. 2082-79-3 | Octadecyl 3-(3,5-di-tert-butyl-4-hydroxyphenyl)propionate | SML = 6 mg/kg |
| • Cas no. 693-36-7  | Distearyl thiodipropionate                                | SML = 5 mg/kg |
| • Cas no. 7429-50-5 | Aluminium   | SML = 1 mg/kg |

The migration tests have been performed according to Regulation (EU) No. 10/2011 (Annex V):

- Test conditions (contact time above 30 days at room temperature):
  - Isooctane: 2 days / 30°C by total immersion
  - 10% ethanol: 10 days / 60°C by total immersion
- Surface to volume ratio:
  - Isooctane: 1,0 dm<sup>2</sup> / 100 ml
  - 10% ethanol: 1,0 dm<sup>2</sup> / 100 ml

#### **USA Food and Drug Administration and US Pharmacopoeia (USP)**

Based upon certificates from our suppliers of resin and masterbatch, we state compliance of Purell PE GF 4760 with relevant parts of FDA title 21 CFR § 177.1520 and of Remafin-EP-White PL00075542-ZT with relevant parts of FDA title 21 CFR §§ 177.1520 & 178.3297.

The products comply with the requirements defined in the USP in relation to the following tests:

- <661> Single Internal Reflectance
- <661> Physicochemical test
- <671> Moisture Vapour Transmission
- <671> Light Transmission

Værløse, April 15, 2021



Christina D. Holder  
Quality Manager



April 27, 2021

## Declaration of Conformity

Primary Packaging Plastics requires from all raw materials suppliers to inform about any animal derived substances used for production of their products and also requests from suppliers to consider and fulfill the relevant regulations of the European Community about the avoidance of TSE/BSE contamination.

If applicable, all suppliers are requested to fulfil the requirements:

- The animal derived substances used for the manufacturing of their polymers are either produced from animals originating from BSE-free countries or are free from SRM (specified Risk Material).
- The manufacture of the animal derived substances involves rigorous processes that meet/exceed the very severe process conditions for inactivating any BSE/TSE agent.

If any of raw materials contain ancillary materials based on fatty acid, such fatty acids might have a number of origins from for example plants, animal or synthetic, where the animal origin is the most common. The use of these subsidiaries as ancillary materials, including packaging for the pharmaceutical-and the foodstuff industries, are regulated through a number of EU directives. Tallow derived materials used in some product fulfill the requirements laid down in the Regulations 1069/2009/EC, and 142/2011/EC, and the "Note for Guidance EMEA/410/01, rev. 3". These directives regulate the general use of these products and specifically security against BSE to transmit to pharmaceutical-or foodstuff products.

Primary Packaging Plastics has received statements or certificates from all suppliers, where they state that:

- their products do not contain specific material of risk (SRM) and that infection does not transmit via their products, or
- their products fulfilled all requirements laid down in relevant regulations concerning BSE/TSE substances.

Yours sincerely,



Marta Słocka-Momotiuk  
Compliance Specialist  
Primary Packaging Plastics

April 14, 2020

## Declaration of Conformity

Primary Packaging Plastics only process raw materials delivered from suppliers and does not add any additional materials to such raw materials. Based upon certificates from raw materials suppliers, Primary Packaging Plastics hereby confirms that:

- Allergens
- Latex
- Melamine
- Bisphenol A
- Phthalates

have not been intentionally added during their production. However, the fact that these substances are not used in these products does not exclude that trace levels of them may be present as a result of the specific characteristics of raw materials and/or of the manufacturing process. Please note that, in any case suppliers do not carry out any specific analyses in order to detect the presence of above mentioned substances.

The information is given to the best of our knowledge and does not include any warranty whatsoever. It must therefore not be misunderstood as guaranteeing specific properties. End-customers have to decide at their own discretion about the suitability of our products for their purposes, based on the explicit descriptions in our product specifications.

Yours sincerely,



Katarzyna Jawor  
Compliance Specialist  
Primary Packaging Plastics



# DECLARATION OF CONFORMITY

**Gerresheimer Vaerloese A/S  
Walgerholm 2-8  
3500 Værløse, Denmark**

Gerresheimer Vaerloese A/S has taken appropriate precautions to reduce the risk for TBA (2,4,6-tribromoanisole) and TCA (2,4,6-trichloroanisole) contamination of products supplied to our customers.

TBA with a threshold of 0.02 PPT and TCA with a threshold of 1 PPT do not introduce any toxicological risks but can have impact in musty molded odor.

Risk for TBA/TCA contamination is included into the risk analysis for the whole manufacturing and handling/storage process in the plant and all wooden pallets used for raw materials, component and final products are heat treated and comply with ISPM 15.

Gerresheimer Vaerloese A/S can only be held responsible for any odor issues due to TBA and/or TCA contamination, if it can be proven that the contamination of the primary plastic packaging has happened before shipment of the products.

Værløse, April 16<sup>th</sup>, 2020



Christina D. Holder  
Quality Manager

# Customer Complaint Report

<input type="checkbox"/> Complaint <input type="checkbox"/> Comment / Remark  Customer report No:	Established by / date:
Customer name / address / country:	Contact person / E-mail / Fax no.:
Article no.:	Date of delivery:
Batch no.:	Invoice no.:
Cavity no.:	Order no.:
Number of defective items:	Total quantity delivered:
Defect observed in: <input type="checkbox"/> Incoming control.....    Sample size: <input type="checkbox"/> Production.....    Quantity of items used: <input type="checkbox"/> Final product(s).....    Quantity of items used: <input type="checkbox"/> Complaint from end-user	
Defect found in: <input type="checkbox"/> One carton <input type="checkbox"/> Several cartons: Quantity _____	Exact production date/time from carton/bag or carton/bag/pallet number:  <input type="checkbox"/> Not available
Are filled/not filled products quarantined: <input type="checkbox"/> Yes – Quantity (filled): <input type="checkbox"/> Yes – Quantity (not filled): <input type="checkbox"/> No <input type="checkbox"/> N/A – no products left	Samples: <input type="checkbox"/> Will be sent <input type="checkbox"/> Not available <input type="checkbox"/> Additional information will be forwarded
Description of defect:	

Received by QA dept. (init. / date): \_\_\_\_\_

## Information requested in relation to complaint investigation

We will kindly ask you to supply us with the answers to the below listed questions. The information is important for us, to make a thorough investigation.

Please return the information as soon as possible, so that we can initiate our investigation.

### Labelling

Company name:	Today's date:
<input type="checkbox"/> Wrong information <input type="checkbox"/> Missing information <input type="checkbox"/> Missing label <input type="checkbox"/> Label difficult to read	
<input type="checkbox"/> Samples have been send <input type="checkbox"/> Samples will be send <input type="checkbox"/> Pictures are available <input type="checkbox"/> No samples or pictures are available	
The defect is observed in <input type="checkbox"/> One bag/carton <input type="checkbox"/> Several bags/cartons - Quantity	
Exact production date and time for all concerned bags	
Exact quantity of defective items/bags/cartons	
How many bags/cartons have been controlled	
Amount of products blocked	
Comments:	

## Information requested in relation to complaint investigation

We will kindly ask you to supply us with the answers to the below listed questions. The information is important for us, to make a thorough investigation.

Please return the information as soon as possible, so that we can initiate our investigation.

### Loose silica gel / loose desiccant / defect on desiccant

Company name:	Today's date:
<input type="checkbox"/> Samples have been send <input type="checkbox"/> Samples will be send <input type="checkbox"/> Pictures are available <input type="checkbox"/> No samples or pictures are available	
Defect observed in: <input type="checkbox"/> Upon reception at your warehouse <input type="checkbox"/> Incoming inspection - sample size/plan: _____ <input type="checkbox"/> Observed in PDS <input type="checkbox"/> Before filling/when opening the cartons <input type="checkbox"/> Before filling/on your line <input type="checkbox"/> After filling <input type="checkbox"/> Market complaint	
Defect observed in <input type="checkbox"/> One bag <input type="checkbox"/> Several bags - Quantity	
Exact production date and time for all concerned bags	
Exact quantity of defective items	
Are there any signs of damage to cap, desiccant or cardboard	
Are there any signs of transport damage to bag or carton	
Quantity of item used or controlled from the batch	
Amount of products blocked	
Amount of filled products blocked	
Comments:	

## Information requested in relation to complaint investigation

We will kindly ask you to supply us with the answers to the below listed questions. The information is important for us, to make a thorough investigation.

Please return the information as soon as possible, so that we can initiate our investigation.

### Mix-up

Company name:		Today's date:	
Ordered product			
Product received			
How many bags/cartons have been controlled			
Amount of products blocked			
Production date and time of all the concerned bags/cartons			
<input type="checkbox"/> Samples have been send <input type="checkbox"/> Samples will be send <input type="checkbox"/> Pictures are available <input type="checkbox"/> No samples or pictures are available			
<p>For for mix-up - both carton label and bag label is important – and it would be helpful, if the pictures also showed the production date/time.</p>			
Comments:			

## Information requested in relation to complaint investigation

We will kindly ask you to supply us with the answers to the below listed questions. The information is important for us, to make a thorough investigation.

Please return the information as soon as possible, so that we can initiate our investigation.

### Partly- or disconnected TE-rings

Company name:	Today's date:
<input type="checkbox"/> Samples have been send <input type="checkbox"/> Samples will be send <input type="checkbox"/> Pictures are available <input type="checkbox"/> No samples or pictures are available	
Quantity of caps with disconnected TE-rings	
Quantity of caps with partly disconnected TE-rings <i>Please specify quantity of broken bridges according to the AQL values/specification.</i>	
Specific cavity number affected	
Defect observed in: <input type="checkbox"/> Incoming inspection - sample size/plan: _____ <input type="checkbox"/> Observed in PDS <input type="checkbox"/> Before filling/when opening the cartons <input type="checkbox"/> Before filling/on your line <input type="checkbox"/> After filling <input type="checkbox"/> Market complaint	
Quantity of item used or controlled from the batch	
Amount of products blocked	
Amount of filled products blocked	
Defect observed in <input type="checkbox"/> One bag/carton <input type="checkbox"/> Several bags/cartons - Quantity	
Exact production date and time for all concerned bags	
Are there signs of damage to the cap/bag/carton	
Comments:	

## Information requested in relation to complaint investigation

We will kindly ask you to supply us with the answers to the below listed questions. The information is important for us, to make a thorough investigation.

Please return the information as soon as possible, so that we can initiate our investigation.

### Product defect

Company name:	Today's date:
<input type="checkbox"/> Samples have been send <input type="checkbox"/> Samples will be send <input type="checkbox"/> Pictures are available <input type="checkbox"/> No samples or pictures are available	
Defect observed in: <input type="checkbox"/> Upon reception at your warehouse <input type="checkbox"/> Incoming inspection - sample size/plan: _____ <input type="checkbox"/> Observed in PDS <input type="checkbox"/> Before filling/when opening the cartons <input type="checkbox"/> Before filling/on your line <input type="checkbox"/> After filling <input type="checkbox"/> Market complaint	
Exact quantity of defective items	
Specific cavity number affected	
Quantity of item used or controlled from the batch	
Amount of products blocked	
Amount of filled products blocked	
Defect observed in <input type="checkbox"/> One bag <input type="checkbox"/> Several bags – Quantity	
Exact production date and time for all concerned bags	
Comments:	

## Information requested in relation to complaint investigation

We will kindly ask you to supply us with the answers to the below listed questions. The information is important for us, to make a thorough investigation.

Please return the information as soon as possible, so that we can initiate our investigation.

### Transport

Company name:	Today's date:
<input type="checkbox"/> Pictures are available <input type="checkbox"/> No pictures are available	
<input type="checkbox"/> A copy of the CMR ("Proof of delivery" from the transporter) has been forwarded <input type="checkbox"/> A copy of the CMR ("Proof of delivery" from the transporter) will be forwarded <input type="checkbox"/> The CMR ("Proof of delivery" from the transporter) is not available	
Defect observed on <input type="checkbox"/> One carton <input type="checkbox"/> Several cartons	
Exact quantity of damaged cartons	
Products can be used	<input type="checkbox"/> yes / <input type="checkbox"/> No
Comments:          	