	Printed, the document is not a controlled document.	Level:
	05016A-0000 Duma Pocket	Approved by: CDH 2021.06.04
		Implementation: 2021.06.04
Document owner: VriQM	Document no.: 1. 9.2.1	Standard Product Database
Version: 5.46		
Document users:		

Product Specification and Certificate

Product no.	05016A-0000
Product name	Duma Pocket 50 ml
Product description	Oval plastic container to be provided with Duma Pocket base. Intended for the packing of tablets and powder.
Design	<ul style="list-style-type: none"> Regulatory drawing A05016A Regulatory Standard drawing B05016A
Raw material	50% PPH 10012, Polypropylene (PP) and 50% PPC 10712, Polypropylene (PP) in compliance with Commission Regulation (EU) No 10/2011, FDA title 21 CFR § 177.1520 'Olefins Polymers' and BfR recommendation VII, Total Petrochemicals. Coloured with 2.8-3.5% white masterbatch, containing approx. 59% titanium dioxide. PPH 10012 Declaration PPC 10712 Declaration
Colour	20-2060-PW-6, Polypropylene (PP) in compliance with Regulation (EU) 10/2011, FDA title 21 CFR §§ 177.1520 & 178.3297 and BfR recommendation VII & IX, Kunststoff-Kemi A/S 20-2060-PW-6 Declaration
Production	<p>Facility: Vaerloese, Denmark</p> <p>Process: The containers are injection moulded</p> <p>Hygiene: The production takes place in clean room</p> <p>Sterilisation: N/A</p>

Measures and Properties

Dimensions:			
Container:		Neck:	
Outside height	70.0 +0.5/-0.5 mm	Outside diameter	22.0 +0.2/-0.2 mm
Outside diameter	50.0 x 24.4 +0.5/-0.5 mm	Inside diameter	16.2 +0.1-0.1 mm
Other dimensions:			
Label height	Max. 59 mm	Volume	Max. 52 ml
Label width	Max. 125 mm	Shelf life	5 years
Weight	14.0 +0.5/-0.5 gr	Bioburden	Max. 50 CFU

Test Results

<p>The container and cap comply with all demands for Moisture Vapour Transmission and Light Transmission and are in accordance with USP <671>. Documentation enclosed.</p> <p>MVT - 05016A-0000/05016B-0000/SEP2016</p> <p>LT - 05016A-0000/MAY2016</p>
<p>The container and cap comply with all demands for Internal Reflectance and Differential Scanning Calorimetry and are in accordance with USP <661.1>. Documentation enclosed. Over time IR spectrum might show absorbance from release agent.</p> <p>IR - PPC10712 / PPH10012 / 20-2060-PW-6</p>

	Printed, the document is not a controlled document.		Level:
	05016A-0000 Duma Pocket		Approved by: CDH 2021.06.04
	Document owner: VriQM	Version: 5.46	Implementation: 2021.06.04
Document users:	Document no.: 1. 9.2.1	Standard Product Database	

DSC PP/AUG2016

The container and cap comply with all demands for Physicochemical Tests set by the United States Pharmacopoeia USP 43 <661.2> Plastic Packaging Systems for Pharmaceutical Use and Biological Reactivity Tests, In vitro set by the USP chapter <87>. Documentation enclosed.

[Physico - PPC 10712/PPH 10012](#)

[In vitro - PPH10012/PPC10712/20-2060-PW-6/JUL2016](#)

Packing and Way of Delivery

The products are packed in 1 PE bag, which is then sealed. The PE bag is put into a cardboard carton, which is sealed with PP-tape. The cartons are packed on pallets, which are 1200 x 800 x 140 mm and weight approximately 23 kg.

Carton dimensions:

Height (mm): 340 Length (mm): 580 Width (mm): 385

Packing information:

Number of items per carton: 500 Volume per carton (m³): 0.08
 Max. number of cartons per pallet: 20 Weight per carton (kg.): 7.9
 Max. height of the pallet (mm): 2300

Labelling

Each carton is provided with a label with the following information:

- Manufacturer name
- Material name and number
- Batch / lot number and quantity
- Customer information (if requested)
- Country of origin
- Shelf life
- Production date and machine number

Recommendation to Storage, Handling and Transportation

Stored inside in clean conditions in its original un-open packaging, protected from direct sunlight and with a temperature between 5 - 35° C and Relative Humidity between 30 - 80 %.

Quality Control

All products are quality controlled according to instructions specified in our quality control system. We therefore guarantee that all deliveries from Primary Packaging Plastics have passed our control procedures and comply with the quality demands mentioned below. If required a certificate of conformance can be issued. The classification of defects and specifications of AQL values are based on ISO 2859 and Quality Assurance of Pharmaceutical and Cosmetic Packaging Materials:

Defect Evaluation List for Blow-moulded Plastic Containers Vol. 23 - ISBN 3-87193-405-6.

Defect Evaluation List for Injection-moulded parts made of Plastic: Closures, Sealing Disks and dosage aids (droppers, etc.) Vol. 22 - ISBN 3-87193-182-9.

Documentation enclosed.

[Quality Control - Pocket](#)

Declaration of Conformity

[DoC EP \(PPH & PPC\)](#)

	Printed, the document is not a controlled document.		Level:
	05016A-0000 Duma Pocket		Approved by: CDH 2021.06.04
	Document owner: VriQM	Version: 5.46	Implementation: 2021.06.04
Document users:	Document no.: 1. 9.2.1	Standard Product Database	

[DoC Food Law \(PPH & PPC\)](#)
[DoC TSE/BSE](#)
[DoC Allergens, Phthalates, BPA, Latex, Melamine](#)
[DoC TBA_TCA](#)

Information on Packaging and Packaging Waste Directive 94/62/EC and/or CONEG

Both container, cap and bag are produced from material, which complies with the directions for plastics material in contact with foodstuffs. The content of heavy metals in the products, the inner bag, and the carton is less than 100 ppm.
The packaging is recyclable for material recovery and/or well suited for energy recovery due to its high energy density. Reuse is technically possible depending on applicable regulations.

REACH

We can confirm that the raw materials used in the product are either pre-registered or exempted from pre-registration.

Complaint Handling

In case that the delivered products are outside specification, complaint must be send in writing to daily contact person in Customer Care Center.

In order to ensure a thorough investigation it is important to send the following basic information:

- Article number
- Batch number
- Cavity number (if related to specific cavities)
- Number of defective items
- Defect observed in
 - a) incoming control including sample size
 - b) production including quantity of items used
 - c) final products including quantity of items used
 - d) market complaint
- Defect found in
 - a) one carton
 - b) several cartons - please specify quantity
- Exact production date/time from carton/bag or carton/bag/pallet number products in quarantine:
 - a) Filled products - Quantity
 - b) Not filled products - Quantity
 - c) No products left
- Description of the defect

The following standard form can be used: 3.1 Customer Complaint Report.

Depending on the defect, additional information will be requested as described in the attached standard forms: 2.5 Information requested in relation to complaints.

It is very important to send samples at the time a complaint is filed, as any delay in these can have an impact on time of investigation. An investigation report is send to Customer within 21 days counting from when complaint, relevant information and samples are received.

	Printed, the document is not a controlled document.		Level:
	05016A-0000 Duma Pocket		Approved by: CDH 2021.06.04
	Document owner: VriQM	Version: 5.46	Implementation: 2021.06.04
Document users:	Document no.: 1. 9.2.1	Standard Product Database	

Important !

Filled or empty products involved in a complaint to Primary Packaging Plastics, must only be destroyed by Customer after written approval from Gerresheimer. Any activity in connection with a complaint where Customer expect Gerresheimer to cover the costs must be approved by Gerresheimer in writing before initiation of the activity.

[Complaint report](#)

[Labelling](#)

[Loose silica gel-loose desiccant-defect on desiccant](#)

[Mix-up](#)

[Partly- or disconnected TE-rings](#)

[Product defect](#)

[Transport](#)

Registrations and Certifications

Primary Packaging Plastics was established in 2020. Before that time the company was working under the following names: Gerresheimer Plastic Packaging, Superfos Pharma, Superfos Pharma Pack, Dudek Plast and Duma.

Documentation, i.e. test reports, certificates etc. issued before July 2020 will be with reference to one of the names above.

Gerresheimer Vaerloese A/S has obtained the following registrations and certifications for Vaerloese and Haarby, Denmark:

ISO 9001, no. 160454-2014-AQ-DEN-DANAK

ISO 14001, no. 156579-2014-AE-DEN-DANAK

ISO 15378, no. 160455-2014-Q-DEN-DNV

ISO 45001, no. 10000341648-MSC-DANAK-DNK

The product is FDA registered in US with the following DMF number:

DMF 12077 - DMF type III Packaging material, Manufactured in Vaerloese - Denmark, Haarby - Denmark.

The product is TPD registered in Canada with the following DMF number:

DMF 2000-108 - Packaging material – Drug Master File. Packaging material, Manufactured in Vaerloese - Denmark, Haarby - Denmark.

The product is registered in Russia with the following number:

C3 2011/11203 – plastic packages in size between 3ml to 3000 ml with accessories.

Revisions

Version:	Implementation:	Revision information:
1	2010.02.08	Transfer to new system and additional information
2.1	2010.02.23	New declaration for raw material and recorection of version number from 1.0 to 2.1
2.2	2010.10.04	Weight per carton changed from 10.0 to 7.9
2.3	2011.02.11	

	Printed, the document is not a controlled document.		Level:
	05016A-0000 Duma Pocket		Approved by: CDH 2021.06.04
	Document owner: VriQM	Version: 5.46	Implementation: 2021.06.04
Document users:	Document no.: 1. 9.2.1	Standard Product Database	

		Correction of sealing method of LDPE bag - has by mistake been stated as heatsealed but the bags are sealed with a cable tie
2.4	2011.03.01	PPC10712 Declaration 2010: Updated PPC 10712 declaration PPH10012 Declaration 2011: Updated PPH 10012 declaration
2.5	2012.01.31	Registrations and Certifications: More precise description of registrations
2.6	2012.03.15	PPC 10712 Declaration 2012: Updated PPH 10012 and PPC 10712: Updated with Regulation (EU) 10/2011 PPH 10012 Declaration 2012: Updated
2.7	2012.05.29	IR - PPC10712 / PPH10012 / 20-2060-PW-6: Updated
2.8	2013.02.25	PPC 10712 Declaration 2012: Updated PPH 10012 Declaration 2012: Updated
2.9	2013.04.08	PPC 10712 Declaration 2013: Updated PPH 10012 Declaration 2013: Updated
2.10	2013.04.15	20-2060-PW-6 Declaration 2013: Updated
2.11	2013.07.24	IR - PPC10712 / PPH10012 / 20-2060-PW-6: Updated
2.12	2014.06.12	PPC 10712 Declaration 2013: Updated
2.13	2014.06.23	PPC 10712 Declaration 2014: Updated
2.14	2014.07.08	20-2060-PW-6 Declaration: Updated with Regulation 202/2014
2.15	2014.07.09	PPH 10012 Declaration: Updated with Regulation 202/2014
2.16	2014.10.02	PPH 10012 Declaration 2014: Updated
3	2015.08.31	Inside diameter changed from 16.2 +0.0/-0.1 to 16.2 +/- 0.1
3.1	2015.08.31	B05016A: Updated
3.2	2016.04.15	PPC 10712 Declaration 2016: Updated
3.3	2016.04.18	PPH 10012 Declaration 2016: Updated 20-2060-PW-6 Declaration: Updated
3.4	2016.05.10	Registrations and Certifications: Updated
4	2016.06.29	Regulatory drawing, Declaration of Conformity and Complaint handling added
4.1	2016.06.29	Quality Control - General text: New classification of defects Quality Control - Duma Pocket: Updated
4.2	2016.08.03	IR - PPC10712 / PPH10012 / 20-2060-PW-6: Updated
4.3	2016.08.12	Kunststof-Kemi 20-2060-PW-6: Regulation 10/2011 and FDA
5	2016.09.02	USP test updated
5.1	2016.09.05	LT - 05016A-0000/MAY2016: Updated MVT - 05016A-0000/05016B-0000/APR2016: Updated
5.2	2016.10.24	MVT - 05016A-0000/05016B-0000/SEP2016: Updated
5.3	2016.11.10	Physico/In vitro - General: Wording changed
5.4	2016.11.16	PPC 10712 Declaration 2016: Updated with 1416/2016 PPH 10012 Declaration 2016: Updated with 1416/2016
5.5	2017.04.03	Caps VRL: Packed in PE bag
5.6	2017.05.15	Added declaration TBA/TCA
5.7	2017.08.08	PPC 10712 Declaration: Updated with 2017/752
5.8	2017.10.05	PPH 10012 and PPC 10712: Approx. instead of about
5.9	2017.10.26	DoC TSE/BSE: Updated (yearly update)

	Printed, the document is not a controlled document.		Level:
	05016A-0000 Duma Pocket		Approved by: CDH 2021.06.04
	Document owner: VriQM	Version: 5.46	Implementation: 2021.06.04
Document users:	Document no.: 1. 9.2.1	Standard Product Database	

5.10	2017.11.28	DoC Allergens, Phthalates, BPA, Latex, Melamine: Yearly update
5.11	2018.02.13	PPH 10012 Declaration : Updated with 752/2017
5.12	2018.03.22	PPC 10712 Declaration: Updated with 2018/213 PPH 10012 Declaration : Updated with 2018/213
5.13	2018.04.09	20-2060-PW-6 Declaration: Updated with 2018/79
5.14	2018.05.28	IR - PPC10712 / PPH10012 / 20-2060-PW-6: Updated
5.15	2018.11.21	20-2060-PW-6 Declaration: Updated due to Reg. 1416/2016
5.16	2019.03.25	DoC TSE/BSE: Yearly update DoC Allergens, Phthalates, BPA, Latex, Melamine: Yearly update
5.17	2019.03.28	DoC EP (PPH & PPC): Yearly update
5.18	2019.04.30	IR/DSC - General: Text updated
5.19	2019.05.15	IR - PPC10712 / PPH10012 / 20-2060-PW-6: Updated
5.20	2019.09.03	Labelling: Updated
5.21	2020.01.28	DoC Food Law (PPH & PPC): Yearly update
5.22	2020.03.24	DoC TSE/BSE: Yearly updated
5.23	2020.04.06	DoC EP (PPH & PPC): Yearly update.
5.24	2020.04.14	DoC TSE/BSE: Updated name to Primary Packaging Plastics DoC Allergens, Phthalates, BPA, Latex, Melamine: Updated name to Primary Packaging Plastics
5.25	2020.04.15	Registrations and Certifications with FDA,TPD and Russia: Updated name to Primary Packaging Plastics
5.26	2020.04.16	DoC TBA_TCA: Updated
5.27	2020.04.20	DoC EP (PPH & PPC): New division name_Primary Packaging Plastic
5.28	2020.04.29	Complaint handling: New division name_Primary Packaging Plastic
5.29	2020.05.19	IR - PPC10712 / PPH10012 / 20-2060-PW-6: Updated
5.30	2020.08.18	Registrations and Certifications with FDA,TPD and Russia: ISO 45001 obtained
5.31	2020.08.19	Physico/In vitro - General: USP 43 <661.2>
5.32	2020.08.25	Quality Control - General text: Updated name Primary Packaging Plastics
5.33	2020.09.09	PPC 10712 Declaration: All Declarations updated PPH 10012 Declaration : All Declarations updated Physico - PPC 10712/PPH 10012: Updated
5.34	2020.11.02	20-2060-PW-6 Declaration: Updated
5.35	2021.02.15	DoC Food Law (PPH & PPC): Yearly update
5.36	2021.03.03	Quality Control - Pocket: Updated with Primary Packaging Plastics
5.37	2021.04.12	DoC EP (PPH & PPC): Yearly update and change of company logo
5.38	2021.04.22	Labelling Loose silica gel-loose desiccant-defect on desiccant
5.39	2021.04.23	Packing and Packing waste directive: Updated. IR - PPC10712 / PPH10012 / 20-2060-PW-6: Yearly update Partly- or disconnected TE-rings Product defect Transport
5.40	2021.04.27	Complaint report DoC TSE/BSE: Change of company logo
5.41	2021.05.04	Mix-up

	Printed, the document is not a controlled document.		Level:
	05016A-0000 Duma Pocket		Approved by: CDH 2021.06.04
			Implementation: 2021.06.04
Document owner: VriQM	Document users:		Document no.: 1. 9.2.1
Version: 5.46			Standard Product Database

5.42	2021.05.07	Labelling
5.43	2021.05.10	Loose silica gel-loose desiccant-defect on desiccant Mix-up Partly- or disconnected TE-rings Product defect Transport
5.44	2021.05.11	Complaint report
5.45	2021.05.12	20-2060-PW-6 Declaration: Updated with SML and dual use substances 03.2021
5.46	2021.06.04	DoC Food Law (PPH & PPC): Updated

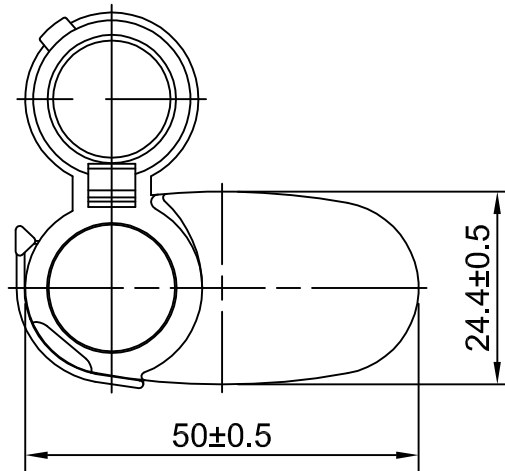
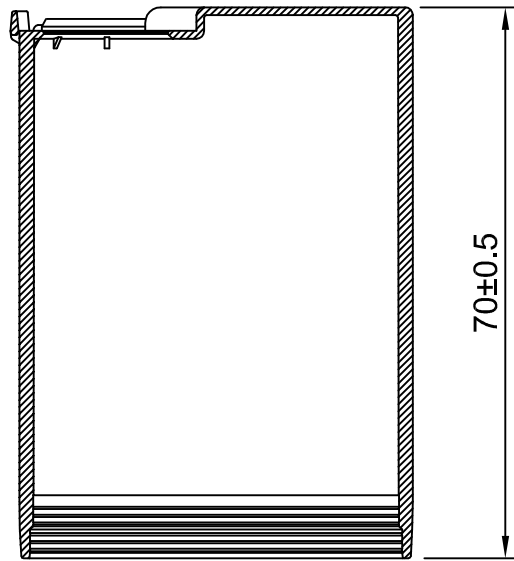

Oval 50ml				
Replaced drawing				
Designer	Hek	23.12.2014	This drawing may not be handed over, copied or used by others	
Released	BS	23.10.2014		
Scale	Drawing Type	Size	Duma Pocket 05016A	A05016A
1 : 1	Regulatory	A4		

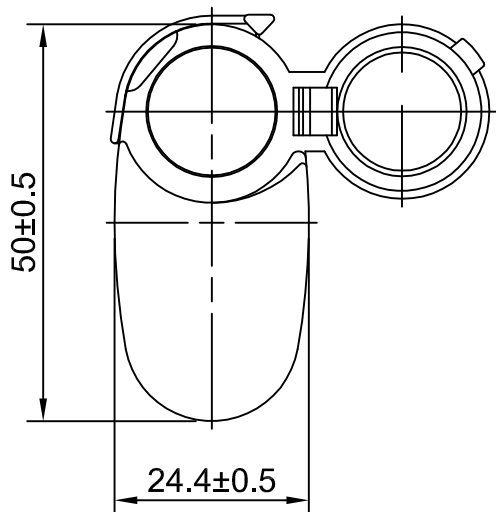
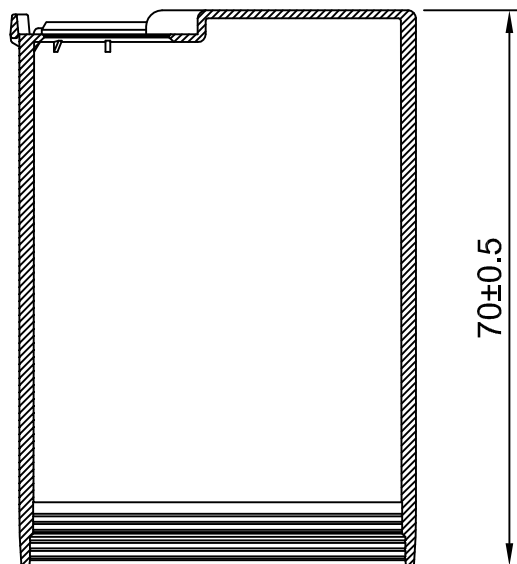
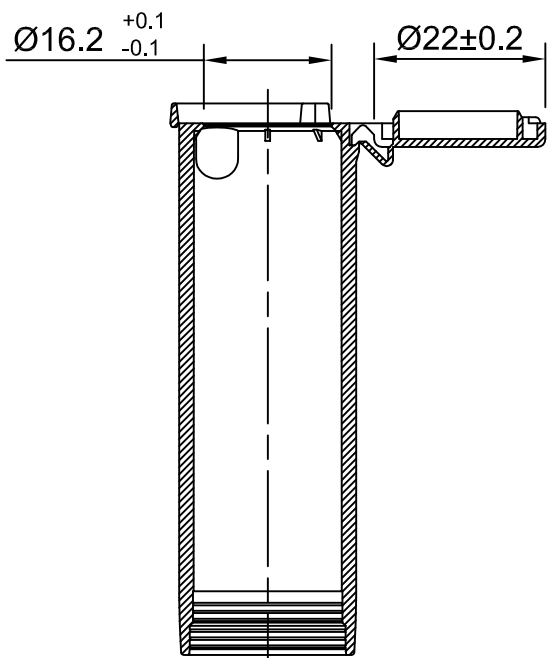

Oval 50ml				
Replaced drawing				
Designer	Hek	28.08.2015	This drawing may not be handed over, copied or used by others	
Released	BS	28.08.2015		
Scale	Drawing Type	Size	Duma Pocket 05016A	B05016A
1 : 1	Standard	A4		

Refining & Chemicals

Total Research & Technology Feluy
Regulatory Affairs
Tel. : +32 (0)64 51 40 67
rc.fer-regaffairs@total.com

Page 1/4

CERTIFICATE N° 38954

Feluy, July 6, 2020

POLYPROPYLENE PPH 10012 grade as produced in Europe**Statement of compliance for food contact applications in Europe****1. Commission Regulation (EU) N° 10/2011:**

We confirm that the above-mentioned Product fulfills the harmonized requirements on plastic materials and articles intended to come into contact with food as described in the Regulation (EU) 10/2011 amended up to the Regulation (EU) 2019/1338 and can therefore be lawfully marketed and used throughout the EU, based on the principle of mutual recognition on the following elements:

- All the monomers, polymer production aids and additives used in the Product are included in the Union list in the Regulation (EU) 10/2011 amended up to the Regulation (EU) 2019/1338.
- For other substances (i.e. polymerization aids) used in the Product: they fall outside of the scope of harmonized Regulation (EU) 10/2011. According to article 19 they have been determined to be suitable for their intended use on the basis of the compliance with article 3 of the Framework Regulation (EC) N° 1935/2004 and potentially applicable national Member State Regulation (i.e. Germany – BfR ¹).

Restrictions and/or migration limits:

This Product contains one or more intentionally added substances with a specific migration limit and/or restrictions defined in Annex I of Regulation 10/2011/EU amended up to the Regulation (EU) 2019/1338 and in BfR (¹).

Experimental tests and/or theoretical calculation for migration carried out on the above mentioned Product (or a specimen representative of this material) covering long term storage at room temperature or below, including heating up to 70 °C for up to 2 hours, or heating up to 100°C for up to 15 minutes with aqueous foodstuffs (i.e simulants A and B) and fatty foodstuffs (Single use, polymer used at 100% and thickness up to 250 µm) have shown that the overall and if relevant the specific migration limit was not exceeded with aqueous foodstuffs (i.e simulants A and B) and fatty foodstuffs including metals of annex II.

¹ Gesundheitliche Beurteilung von Kunststoffen im Rahmen des Lebensmittel- und Bedarfsgegenstandegesetzes (BfR) : Empfehlung VII: Polypropylen Stand 01.06.2019 – 221 Mitteilung-B. Gesundh.BI.61(2018) 236

Refining & Chemicals

Total Research & Technology Feluy
Regulatory Affairs
Tel. : +32 (0)64 51 40 67
rc.fer-regaffairs@total.com

Page 2/4

CERTIFICATE N° 38954

Feluy, July 6, 2020

POLYPROPYLENE PPH 10012 grade as produced in Europe

For other specific conditions of use, not covered above, it pertains to downstream users to check by appropriate overall and/or specific migration tests on the final material or article the suitability for contact with different food-types, various end-use conditions and different thickness. However these are beyond the control of TOTAL RESEARCH & TECHNOLOGY FELUY and are a part of the responsibility of the user of the above-mentioned Product.

Dual use additive:

We inform you that the above-mentioned Product contains one or more substance(s) defined as 'dual use additive(s)'. The downstream user must contact us for additional information and you must inform the downstream user accordingly.

NIAS

Total is well aware of the legal requirements of Regulation 1935/2004/EC and 10/2011/EU, namely materials and articles coming into contact with food shall be manufactured so that they do not transfer their constituents to food in quantities that could endanger human health or bring about unacceptable change to the composition of the food. This does not only include constituents which are intentionally added but also non-intentionally added substances (NIAS).

We receive from some of our suppliers information regarding potential NIAS with restrictions as listed in Commission Regulation (EU) N° 10/2011.

We shall supply the TOTAL REFINING & CHEMICALS proprietary information needed to perform the migration measurements/analyses upon request.

For obtaining more information, please send directly an e-mail to: rc.fer-regaffairs@total.com

2. Regulation (EC) N°1935/2004 of the European Parliament & of the Council (Framework Regulation)

We hereby confirm that the above-mentioned Product, when used under normal or foreseeable conditions of use, is expected to meet the relevant requirements laid down in Regulation 1935/2004/EC.

Moreover, we inform you that the organoleptic properties are influenced by the conditions of use i.e. temperature, type of packaged foodstuff, storage conditions. Consequently, the packaging has to be controlled by the downstream user following the specific end-use conditions of use.

Refining & Chemicals

Total Research & Technology Feluy
Regulatory Affairs
Tel. : +32 (0)64 51 40 67
rc.fer-regaffairs@total.com

Page 3/4

CERTIFICATE N° 38954

Feluy, July 6, 2020

POLYPROPYLENE PPH 10012 grade as produced in Europe**3. Commission Regulation (EC) N° 2023/2006 (GMP)**

We inform you that the production of the above-mentioned Product is systematically reviewed with regards to good manufacturing practice (GMP) using our ISO 9001 System, and following the Plastics Europe guideline specifically dedicated to GMP.

Therefore we can state that the above-mentioned Product meets the relevant requirements laid down in Commission Regulation (EC) 2023/2006.

DISCLAIMER:

Our certificate is only valid for as far as above mentioned Product was bought from Total or its distributor and does not cover:

- Any modification of the above-mentioned Product by any addition of any other product or ingredient to it;
- Any prejudicial modification of the above-mentioned Product resulting from a processing of it;
- An inadequate use and/or storage of the above-mentioned Product and/or of the finished articles.

Unless specifically indicated in a regulatory certificate of compliance, the products mentioned herein are not suitable for applications in the pharmaceutical or medical sector. Under no circumstances are any products sold by Total Refining & Chemicals suitable for humans or animals in the following applications: (i) Implantable devices intended for human or animal body (ii) Devices intended to be used in contact with internal body fluids (iii) Devices intended to be used in contact with internal body tissues.

Information contained in this publication is true and accurate at the time of publication and to the best of our knowledge. The nominal values stated herein are obtained using laboratory test specimens. Before using one of the products mentioned herein, customers and other users should take all care in determining the suitability of such product for the intended use.

The Companies within Total Refining & Chemicals do not accept any liability whatsoever arising from the use of this information or the use, application or processing of any product described herein. No information contained in this publication can be considered as a suggestion to infringe patents. The Companies disclaim any liability that may be claimed for infringement or alleged infringement of patents.



Refining & Chemicals

Total Research & Technology Feluy
Regulatory Affairs
Tel. : +32 (0)64 51 40 67
rc.fer-regaffairs@total.com

Page 4/4

CERTIFICATE N° 38954

Feluy, July 6, 2020

POLYPROPYLENE PPH 10012 grade as produced in Europe

The present certificate is valid for a period of eighteen months starting from the date first above written and replaces any earlier certificate relating on this subject which should be considered as null and void. Upon the expiration of this certificate, we can issue a new one at your request. In case of change during this period a new certificate will be issued automatically; kindly forward it to any recipient of the present certificate.

TOTAL RESEARCH & TECHNOLOGY FELUY

C. RAIMOND
Regulatory Affairs

F. RADERMACHER
Regulatory Affairs, Manager

Issued by an electronic system

Refining & Chemicals

Total Research & Technology Feluy
Regulatory Affairs
Tel. : +32 (0)64 51 40 67
rc.fer-regaffairs@total.com

Page 1/2

CERTIFICATE N° 38955

Feluy, May 19, 2020

POLYPROPYLENE PPH 10012 grade as produced in Europe**STATEMENT OF COMPLIANCE FOR FOOD CONTACT IN THE UNITED STATES OF AMERICA**

We confirm that this product fulfils the requirements on materials used for articles or components of articles intended to come into contact with food as described in:

- Code of Federal Regulations, Food and Drugs (FDA) Title 21- 2019 - §177.1520 : Olefins Polymers; (a) (1) (i), (b) and (c) item 1.1a, §176.170(c), Food Types I through IX of Table 1, under conditions of use A through H of Table 2 .

General use conditions (food contact):

It pertains to downstream users of materials intended to come into contact with food, to ensure that the final materials or articles do not bring about an unacceptable change in the composition of the food, or bring about a deterioration in the organoleptic characteristics which render it unfit.

It pertains to downstream users to check by appropriate tests on the final material or article the suitability for contact with different food-types and various end-use conditions. For high temperature applications tests shall be carried out under the worst foreseeable conditions of use in which physical or other changes do not take place and specific precautions must be taken during the end-use in the most severe temperatures to ensure that the polymer remains functional. The maximum testing temperature is governed by the phase transition temperature of the polymer.

DISCLAIMER:

Our certificate is only valid for as far as above mentioned Product was bought from Total or its distributor and does not cover:

- Any modification of the above-mentioned Product by any addition of any other product or ingredient to it;
- Any prejudicial modification of the above-mentioned Product resulting from a processing of it;
- An inadequate use and/or storage of the above-mentioned Product and/or of the finished articles.



Refining & Chemicals

Total Research & Technology Feluy
Regulatory Affairs
Tel. : +32 (0)64 51 40 67
rc.fer-regaffairs@total.com

Page 2/2

CERTIFICATE N° 38955

Feluy, May 19, 2020

POLYPROPYLENE PPH 10012 grade as produced in Europe

Unless specifically indicated in a regulatory certificate of compliance, the products mentioned herein are not suitable for applications in the pharmaceutical or medical sector. Under no circumstances are any products sold by Total Refining & Chemicals suitable for humans or animals in the following applications: (i) Implantable devices intended for human or animal body (ii) Devices intended to be used in contact with internal body fluids (iii) Devices intended to be used in contact with internal body tissues.

Information contained in this publication is true and accurate at the time of publication and to the best of our knowledge. The nominal values stated herein are obtained using laboratory test specimens. Before using one of the products mentioned herein, customers and other users should take all care in determining the suitability of such product for the intended use.

The Companies within Total Refining & Chemicals do not accept any liability whatsoever arising from the use of this information or the use, application or processing of any product described herein. No information contained in this publication can be considered as a suggestion to infringe patents. The Companies disclaim any liability that may be claimed for infringement or alleged infringement of patents.

The present certificate is valid for a period of eighteen months starting from the date first above written and replaces any earlier certificate relating on this subject which should be considered as null and void. Upon the expiration of this certificate, we can issue a new one at your request. In case of change during this period a new certificate will be issued automatically; kindly forward it to any recipient of the present certificate.

TOTAL RESEARCH & TECHNOLOGY FELUY

C. RAIMOND
Regulatory Affairs

F. RADERMACHER
Regulatory Affairs, Manager

Issued by an electronic system

Refining & Chemicals

Total Research & Technology Feluy
 Regulatory Affairs
 Tel. : +32 (0)64 51 40 67
 Fax.: +32 (0)64 51 41 49
 rc.fer-regaffairs@total.com

Certificate N° ARP/20L00266
 Page 1 of 8

Letter: ARP/20L00266

Feluy, 11/03/2020

PRODUCT STEWARDSHIP CERTIFICATE
ALL POLYPROPYLENE PPC, PPH, PPM, PPR, PPS, ACESO® AND LUMICENE® PRODUCTS (Manufactured in Europe)
A. ABSENCE OF SUBSTANCES

We hereby confirm that we do not intentionally use the following substances as additive* in the manufacturing of the above-mentioned Products:

1	ALLERGEN SUBSTANCES as listed in Annex II of Regulation (EU) 1169/2011	
2	ANTHRAQUINONE	CAS 84-65-1
3	ANTIMONY TRIOXIDE	CAS 1309-64-4
4	AROMATIC AMINES as listed in Regulation 1907/2006/EC Annex XVII Appendix 8	
5	ASBESTOS as listed in Regulation 1907/2006/EC Annex XVII	
6	AZOCOLORANTS as listed in Regulation 1907/2006 Annex XVII Appendixes 8 and 9	
7	BENZENE	CAS 71-43-2
8	BENZOPHENONE DERIVATIVES	We mean the following substances by benzophenone derivatives : Benzophenone (CAS 119-61-9), 2-hydroxybenzophenone (CAS 117-99-7), 3-hydroxybenzophenone (CAS 13020-57-0), 4-hydroxybenzophenone (CAS 1137-42-4), 4-methylbenzophenone (CAS 134-84-9),
9	BIOCIDAL PRODUCTS as defined in Article 3(1)(a) of the Regulation (EU) No 528/2012	
10	BISPHENOL A, BISPHENOL B, BISPHENOL F and BISPHENOL S	CAS 80-05-7, CAS 77-40-7, CAS 620-92-8 and CAS 80-09-1
11	BHA (ter-Butyl-4-hydroxyanisole)	CAS 25013-16-5
12	BHT (2,6-di-ter-butyl-p-cresol)	CAS 128-37-0

13	CHLORINATED ALIPHATIC COMPOUNDS	We mean the following substances by chlorinated aliphatic compounds: tetrachloromethane (CAS 56-23-5), 1,1,2,2-tetrachloroethane (CAS 79-34-5), 1,1,1,2-tetrachloroethane (CAS 630-20-6), pentachloroethane (CAS 76-01-7), trichloromethane (chloroform; CAS 67-66-3), 1,1,2-trichloroethane (CAS 79-00-5), 1,1-dichloroethylene (CAS 75-35-4), 1,1,1-trichloroethane (CAS 71-55-6).
14	CHLOROFLUOROCARBONS (CFC), HYDROGENATED CHLOROFLUOROCARBONS (HCFC) AND HALONES	
15	CMR SUBSTANCES as listed in Regulation 1272/2008/EC Annex VI	
16	CONFLICT MINERALS (Section 1502 of the Dodd-Frank Wall Street Reform and Consumer Act)	We mean the following substances by conflict minerals: cassiterite, columbite-tantalite, wolframite, tin, tantalum, tungsten and gold
17	COSMETIC prohibited ingredients as listed in Annex II and III of the REGULATION (EC) 1223/2009 on COSMETIC PRODUCTS	
18	DIMETHYLFUMARATE	CAS 624-49-7
19	DIOXINS AND DIFURANS	
20	ENDOCRINE DISRUPTORS category I and II mentioned in Annex 13 of the final report of BKH STUDY 2000	Nevertheless, we inform you that traces of Dibutylphthalate (DBP) may be present in some of our products as catalyst modifier residues. The maximum residue would not exceed 1 ppm.
21	EPOXIDIZED SOYA BEAN OIL (ESBO)	CAS 8013-07-8
22	EPOXY DERIVATIVES Regulation 1895/2005/EC	2,2-bis (4-hydroxyphenyl) propane bis (2,3-epoxypropyl) ether ('BADGE'), bis(hydroxyphenyl) methane bis (2,3-epoxypropyl) ethers ('BFDGE') and novolac glycidyl ethers ('NOGE')
23	ETHANOL	CAS 64-17-5
24	FLAME RETARDANTS	This include Hexabromocyclododecane (HBCD)
25	FORMALDEHYDE	CAS 50-00-0
26	HALOGENS	We mean the following substances by Halogens: Fluorine (CAS 7782-41-4), Chlorine (CAS 7782-50-5), Bromine (CAS 7726-95-6), Iodine (CAS 7553-56-2)
27	HEAVY METALS Directive 94/62/EC and Directive 2004/12/EC	The overall concentration of cadmium, mercury, lead and chromium is lower than 100 ppm (w/w).
28	ISOPROPYLTHIOXANTHONE (ITX)	CAS 5495-84-1 and CAS 83846-86-0
29	LATEX	We mean the following by latex: "a white, tacky, aqueous suspension of a hydrocarbon polymer occurring naturally in some species of trees, shrubs, or plants, or made synthetically".
30	MELAMINE and CYANURIC ACID	CAS 108-78-1 / CAS 108-80-5

31	METALS as listed beside	Nickel, Barium, Cobalt, Arsenic
32	MOSH (Mineral Oil Saturated Hydrocarbons), MOAH (Mineral Oil Aromatic Hydrocarbons), & Mineral Oil	However, we inform you that some trace amount of Mineral Oil can be present in some of here above mentioned products as a manufacturing process residue. This Mineral Oil is included in the Union List of the authorized substances for the manufacturing of plastic materials intended to come into contact with food
33	N_METHYLPYRROLIDONE (NMP)	CAS 872-50-4
34	NONYLPHENOL AND NONYLPHENOLETHOXYLATES as listed in Regulation 1907/2006/EC Annex XVII	
35	ORGANOTIN COMPOUNDS	We mean the following substances by organotin compounds: Monobutyltin compounds (MBT), Dibutyltin compounds (DBT), Dioctyl Tin compounds (DOT), Tributyltin compounds (TBT), Triphenyltin compounds (TPT) and Tributyltin Oxide (TBTO)
36	OZONE-DEPLETING SUBSTANCES - Regulation 1005/2009/EC - The Montreal Protocol on Substances that deplete the Ozone Layer, as last adjusted and/or amended in Montreal 19-2007 (UNEP-United Nation Environment Program) - The United States (Clean Air Act, as amended in 1990, title VI, section 602 (a), class I and II.	CFCs, Halons, Other fully halogenated CFCs, Carbon tetrachloride, 1,1,1-Trichloroethane (Methyl chloroform), Hydrochlorofluorocarbons (HCFC), Hydrobromofluorocarbons (HBFC), Methyl bromide, Bromochloromethane.
37	PARABENS as listed in Annex II and V of the Cosmetic Regulation 1223/2009/EC	
38	PENTACHLOROPHENOL and its salts and esters as listed in Regulation 1907/2006/EC Annex XVII	
39	PERFLUOROCTANE SULFONATE (PFOS) AND PERFLUOROCTANOIC ACID (PFOA)	
40	PESTICIDES, HERBICIDES as defined in Article 2 of the REGULATION (EC) No 1107/2009	
41	PHTHALATES	Nevertheless, we inform you that traces of Phthalates may be present in some of our products, as catalyst modifier residues. The maximum residue would not exceed 1ppm.
42	POLYBROMOBIPHENYLS and POLYBROMODIPHENYLETERS - Regulation 1907/2006/EC Annex XVII - Directive 2011/65/EU	This includes penta-, octa-, decabromobiphenylethers.
43	POLYCHLORINATED BIPHENYLS (PCB)	
44	POLYCHLORINATED NAPHTHALENES (PCN)	
45	POLYCHLORINATED TERPHENYLS (PCT) Regulation 1907/2006/EC Annex XVII	

46	POLYCYCLIC AROMATIC HYDROCARBONS (PAH) as listed in Regulation 1907/2006/EC Annex XVII (1272/2013/EC)	
47	POLYVINYLCHLORIDE (PVC), VINYLCHLORIDE MONOMER, POLYVINYLIDENE CHLORIDE (PVDC) VINYLIDENE CHLORIDE MONOMER	
48	POP - Persistent Organic Pollutants As listed in Regulation EU 2019/1021	
49	PROPOSITION 65, January 3, 2020	Chemicals listed in the Proposition 65, California Safe Drinking Water and Toxic Enforcement Act of 1986, dated January 3, 2020 (chemicals list that you can find at the following web address: http://www.oehha.org/prop65/prop65_list/Newlist.html). We can hereby confirm that we do not use the chemicals mentioned in this list as additive*. However, some trace amount of Di-isobutyl phthalate (DIBP) and Dibutyl phthalate (DBP), may be present in some of our products, as catalyst modifier residues.
50	RADIOACTIVE SUBSTANCES as defined in Directive 2013/59/EURATOM	Laying down basic safety standards for the protection of the health of workers and the general public against the dangers arising from ionizing radiation.
51	RECYCLED MATERIALS as defined in Commission Regulation 282/2008/EC	
52	SEMICARBAZIDE and AZODICARBONAMIDE	
53	SHORT CHAINED CHLORINATED PARAFFINS	Short-Chain Chlorinated Paraffins (SCCPs) include all individual chemicals or mixtures that contain: $C_xH_{(2x-y+2)Cl_y}$. Where $x = 10-13$; $y = 3-12$; and the average chlorine content ranges from approximately 40 to 70 percent with the limiting molecular formulas set at $C_{10}H_{19}Cl_3$ and $C_{13}H_{16}Cl_{12}$
54	SILICONE	CAS 63148-53-8, 63394-02-5, 90337-93-2, 63148-62-9
55	STYRENE	CAS 100-42-5
56	TITANIUM ACETYL ACETONATE (TAA)	CAS 77927-72-9
57	TRICLOSAN (2,4,4'-Trichloro-2'-hydroxydiphenyl Ether) Decision 2010/169/EU	CAS 3380-34-5
58	TRIS(NONYLPHENYL) PHOSPHITE (TNPP)	CAS 26523-78-4

* Additive as defined in Regulation (EU) 10/2011

However, since we do not systematically perform specific test to verify the potential presence of these substances in the above-mentioned Products, we cannot guarantee that there is no trace amount of these substances, as impurity or otherwise, in the above-mentioned Products. Moreover, it cannot be excluded that in specific conditions of processing or incineration certain of the above-mentioned substances might be generated as mentioned in the relevant safety data sheet.

B. COMPLIANCE WITH REGULATIONS.**1. CONEG (Coalition of the North-eastern Governors (CONEG, USA))**

The above-mentioned Products meet the requirements of less than 100ppm overall concentration of cadmium, mercury, lead and chromium

2. DECRET 2007-1467 (Article 4) and ENVIRONMENTAL CODE (book V-title IV-chapter III-section V)-dated on 10 November 2008.

We inform you that the "Décret" 98-638 is repealed by article 4 of the French "Décret" 2007-1467 (dated 12 October 2007). We hereby certify that the above-mentioned Products meet the requirements of the article R543-44 item 2b and article R543-45 of Environmental Code (book V) imposing to take into account environmental requirements in the conception and in the manufacturing of packaging material as far as the following articles are concerned:

Article R 543-44 - item 2 (b):

- the above mentioned Products are intended for the manufacture of packaging materials;
- the above-mentioned Products are recyclable by melting and pelletizing;
- the above-mentioned Products have a heat of combustion sufficient to enable to optimize energy recovery (*).

Article R 543-45:

The total of the concentrations of lead + cadmium + mercury + hexavalent chromium does not exceed 100 ppm.

We kindly remind you that the above-mentioned articles of the Code concern the packaging material as end product, for which we cannot provide any guarantee.

(*). The control of the combustion conditions and the technical measures related thereto cannot be controlled by the manufacturer of the above-mentioned Products and thus do not fall within his responsibility."

3. Directive 76/769/EC and Reach Annex XVII

Directive 76/769/EC relating to restrictions on the marketing and use of certain dangerous substances and preparations, established in its Annex I restrictions for certain dangerous substances and preparations. Regulation 1907/2006/EC (Reach Regulation) repealed and replaced Directive 76/769/EC from 1 June 2009 onwards. Annex XVII, published as Regulation 552/2009/EC amending Regulation 1907/2006/EC, replaces Annex I to Directive 76/769/EC. We herewith confirm that the above-mentioned Products comply with Regulation 552/2009/EC.

4. END OF LIFE VEHICLES Directive 2000/53/EC

We hereby confirm that the above-mentioned Products comply with the Directive 2000/53/EC on end of life of vehicles with respect to the heavy metals content limit defined in the notes of the Decision 2002/525/EC because the overall concentration of lead, chromium and mercury is lower than 0.1% by weight, and the concentration of cadmium is lower than 0.01% by weight.

5. GENETICALLY MODIFIED ORGANISMS

For PPH 8025, PPH 9020, PPH 12020, PPR 7220, PPR 7227, PPR 9220, PPR 10231, PPR 10232, PPR 12232, PPR 19R01, Lumicene® MR30MC2, Lumicene® MR60MC2, Lumicene® MR30MX6:

We hereby confirm that we received below indications from our current additive* suppliers :

- 1) The majority of additives* used in the here above mentioned products are not GMO derived
- 2) Whilst the others could derive from Genetically Modified Organism (GMO)

For other Polypropylene products mentioned on page 1, we hereby confirm that we received confirmation of our suppliers of additives* mentioning the absence of genetically modified organisms (GMO).

6. HALAL/KOSHER

We inform you that the above-mentioned products have not received Halal/Kosher certification. However, we can hereby confirm that we do not use, Ethanol (CAS No 64-17-5), as additive (as defined in Regulation (EU) 10/2011) in the here above mentioned products.

7. PACKAGING AND PACKAGING WASTE Directive 94/62/EC:

We hereby confirm that the above-mentioned Products comply with Directive 94/62/EC and Directive 2004/12/EC on Packaging Waste with respect to the heavy metals content limit because the overall concentration of cadmium, mercury, lead and chromium is lower than 100 ppm (w/w)(to be checked for other requirements). In addition, the above-mentioned Products have the potential to be recycled according to these requirements.

8. RoHS II and III Directive 2011/65/EC and 2015/863/EU

We hereby inform you that Directive 2011/65/EU (up to amendment (EU) 2020/366) on the restriction of the use of certain hazardous substances in electrical and electronic equipment (RoHS) does not cover our Polymers as "raw materials" but it only applies to the "electrical and electronic equipment" as finished products defined in the Annex I of Directive 2011/65/EU.

Nevertheless, we hereby confirm that neither Polybromo biphenyls (PBB), Polybromo diphenylethers (PBDE), Bis(2-ethylhexyl) phthalate (DEHP), Butyl benzyl phthalate (BBP), Dibutyl phthalate (DBP), Diisobutyl phthalate (DIBP) are intentionally used in the manufacturing of the above-mentioned Products at a threshold level higher than 0.1%. We confirm that the above-mentioned Products do not contain mercury, lead and hexavalent chromium at a threshold level higher than 0.1% (w/w) each, and of cadmium at a threshold level higher than 0.01% (w/w).

However, since we do not perform specific tests to verify the absence of these substances, we cannot guarantee that there is no trace amount of these substances, as impurity or otherwise, in the above-mentioned product.

9. WASTE ELECTRICAL AND ELECTRONIC EQUIPMENT Directive 2012/19/EU

We hereby inform you that Directive 2012/19/EU (up to amendment (EU) 2018/849) on waste electrical and electronic equipment (WEEE) does not cover our Polymers as "raw materials" but it only applies to the "electrical and electronic equipment" as finished products defined in Article 3 and classified in categories set out in Annex III of Directive 2012/19/EU.

Nevertheless, we hereby confirm that neither Polychlorinated biphenyls (PCB), Polychlorinated terphenyls (PCT), chlorofluorocarbons (CFC), hydrochlorofluorocarbons (HCFC) or hydrofluorocarbons (HFC), brominated flame retardants, asbestos are

intentionally used in the manufacturing of the above-mentioned product at a threshold level higher than 0.1%.

We hereby confirm that the above-mentioned product does not contain mercury, lead and hexavalent chromium at a threshold level higher than 0.1% (w/w) each, and of cadmium at a threshold level higher than 0.01% (w/w).

However, since we do not perform specific tests to verify the absence of these substances, we cannot guarantee that there is no trace amount of these substances, as impurity or otherwise, in the above-mentioned product.

10. SAFETY DATA SHEETS (Regulation 1907/2006/EC)

We recommend before using the above-mentioned Products to carefully read the Safety Data Sheets which can be downloaded from the website: <http://www.polymers.total.com>. Our customers receive automatically a Safety Data Sheet after their first order and when they make a new order after a period that is longer than 12 months. They will also receive automatically a Safety Data Sheet when modifications have been made.

11. TRANSMISSIBLE SPONGIFORM ENCEPHALOPATHY (TSE)

We hereby confirm that we received confirmation of our suppliers of additives* used in the above mentioned products that when substances of animal origin are used, they comply with the requirements stipulated in the *Note for guidance on minimising the risk of transmitting animal spongiform encephalopathy agents via human and veterinary medicinal products* (EMA/410/01 rev.3).

12. VOLATILE ORGANIC COMPOUNDS (VOC)

We hereby inform you that a representative grade of the here above-mentioned product has been analyzed by "Automated Thermal Desorption Gas Chromatography – internal method" for VOC and our results were lower than the threshold concentration pointed out (3% w/w) in Swiss Ordinance on the Incentive Tax on Volatile Organic Compounds (OVOC) of 12 November 1997 (Status as of March 1st, 2013).

* Additive as defined in Regulation (EU) 10/2011

C. NORMS AND STANDARDS

We can hereby confirm that we do not use as additive* any substances listed in these norms and standards above the limit values. The here above mentioned products are plastics and we therefore made reference to the respective parts of these norms and standards. Furthermore, we inform you that we do not test each grade we sell to check the potential presence of trace amounts of each chemicals hereafter listed which could be present in the here above mentioned products as impurities or otherwise.

1. **IKEA IOS-MAT-0010** (version AA-10911-15, dated 2019-12-20), **IKEA IOS-MAT-0054** (version AA-92520-11, dated 2018-11-14), **IKEA IOS-MAT-0195** (version AA-2208470-2, dated 2020-01-20), **IKEA IOS-PRG-0021** (version AA-31847-7, dated 2011-10-14).
2. **GADSL - GLOBAL AUTOMOTIVE DECLARABLE SUBSTANCE List – 2019**

* Additive as defined in Regulation (EU) 10/2011

Refining & Chemicals

Total Research & Technology Feluy
Regulatory Affairs
Tel. : +32 (0)64 51 40 67
Fax.: +32 (0)64 51 41 49
rc.fer-regaffairs@total.com

Certificate N° ARP/20L00266
Page **8** of **8**

Our certificate does not cover:

- any modification of The Product by any addition of any other product to it,
- any prejudicial modification of The Product resulting from a processing of The Product,
- an inadequate use and/or storage of The Product and of the finished articles.

Information contained in this publication is true and accurate at the time of publication and to the best of our knowledge. The present certificate is based on the status of the legislation at the date written above and is valid until **end of August 2021**. This certificate cancels and supersedes any prior version thereof. It can be renewed upon request.

We are at your disposal for any further information you may need and remain,

Yours faithfully,
Total Research & Technology Feluy

B. KLUYSKENS
Regulatory Affairs

F. RADERMACHER
Regulatory Affairs, Manager

Refining & Chemicals

Total Research & Technology Feluy
Regulatory Affairs
Tel. : +32 (0)64 51 40 67
Fax.: +32 (0)64 51 41 49
rc.fer-regaffairs@total.com

GERRESHEIMER Boleslawiec
For the attention of Katarzyna Jawor
Boleslawiec
PL - Poland

Letter: ARP/20L00398

Feluy, 23/03/2020

Dear Madam,

Concern: POLYPROPYLENE PPC 10712, POLYPROPYLENE PPH 10012

NITROSAMINES (EMA/189634/2019)

This statement is in response to your request regarding the Nitrosamines impurities as mentioned in EMA/189634/2019 from the European Medicines Agency (EMA) in the here above-mentioned product. In September 2019 EMA began a review under Article 5(3) of Regulation (EC) No 726/2004 to provide guidance to marketing authorisation holders on how to avoid the presence of nitrosamine impurities in human medicines.

We can hereby confirm that we do not intentionally use the substances listed below in the manufacturing of here above-mentioned product.

We hereby inform you that to the best of our knowledge nitrosamines compounds would not be present in the here above-mentioned product sold and supplied by Total Refining & Chemicals.

However, we inform you that some traces of amines (primary, secondary or tertiary), at a ppb level, may be present in the here above-mentioned product.

However, since we do not perform specific tests to verify the potential presence of nitrosamines compounds, amines, nitrosating agents and substances listed in the here above-mentioned product, we cannot guarantee that there is no trace amount of some of nitrosamines compounds, amines, nitrosating agents and substances listed below as impurity or otherwise, in the here above-mentioned product.

Our certificate does not cover :

- any modification of the warranted product by any addition of any other product to it,
- any prejudicial modification of the warranted product resulting from a processing of the product,
- an inadequate use and/or storage of the material and of the finished articles.

The present certificate is valid for a period of one year starting from the date first above written. It can then be renewed upon request.

We are at your disposal for any further information you may need and remain,

Yours faithfully,
Total Research And Technology Feluy

B. KLUYSKENS
Regulatory Affairs

F. RADERMACHER
Regulatory Affairs, Manager

Issued by an electronic system

1/3

SA TOTAL RESEARCH & TECHNOLOGY FELUY NV

Zone Industrielle C – B-7181 Senefte (Feluy)

Tél. : +32 (0)64 51 41 11 - Fax. : +32 (0)64 54 08 45 - Courriel : research-feluy@total.com

RPM Charleroi 0438.021.316 T.V.A. BE 0438.021.316 – BNP Paribas Fortis IBAN BE48 2100 4738 2027 BIC GEBABEBB

Refining & Chemicals

Total Research & Technology Feluy
Regulatory Affairs
Tel. : +32 (0)64 51 40 67
Fax.: +32 (0)64 51 41 49
rc.fer-regaffairs@total.com

GERRESHEIMER Boleslawiec
For the attention of Katarzyna Jawor
Boleslawiec
PL - Poland

List of Substances:

- Sodium Nitrite (NaNO₂, CAS 7632-00-0)
- Nitrocellulose (EC 936-908-7)
- Ozone (CAS 10028-15-6)
- Nitrous Acid (HNO₂, CAS 7782-77-6)
- Nitric Acid (HNO₃, CAS 7782-77-6)
- Nitric Oxid (NO, CAS 10102-43-9)
- Nitrosyl halides (e.g. ClNO, BrNO)
- Dinitrogen trioxide (N₂O₃, CAS 10544-73-7)
- Dinitrogen tetroxide (N₂O₄, CAS 10544-72-6);
- Organic nitrites (e.g. t-BuONO)
- Formaldehyde (CAS 50-00-0)
- Amide solvents
- N,N-dimethylformamide (DMF, CAS 68-12-2)
- N-Methylpyrrolidone (NMP, CAS 120-94-5)
- N,N-dimethylacetamide (DMA, CAS 127-19-5)
- Hydroxylamine (NH₂OH, CAS 7803-49-8)
- N-nitro-N-methyl-4-aminobutyric acid (NMBA, CAS 61445-55-4)
- N-nitrosodimethylamine (NDMA, CAS 62-75-9)
- N-nitrosométhyléthylamine (CAS 10595-95-6)
- N-nitrosodiethylamine (NDEA, CAS 55-18-5)
- N-nitrosodipropylamine (CAS 621-64-7)
- N-nitrosodibutylamine (CAS 924-16-3)
- N-nitrosomorpholine (CAS 59-89-2)
- N-nitrosopiperidine (CAS 100-75-4)
- N-nitrosopyrrolidine (CAS 930-55-2)
- N-nitrosodiethanolamine (CAS 1116-54-7)
- N-Methyl-N'-Nitro-N-Nitrosoguanidine (CAS 70-25-7)
- N-Nitrosoethyl-n-butylamine (CAS 4549-44-4)
- N'-Nitrosoanabasine (CAS 37620-20-5)
- 4-(Methylnitrosamino)-1-(3-pyridyl)-1-butanol (CAS 76014-81-8)
- 4-(Methylnitrosamino)-1-(3-pyridyl)-1-butanone (CAS 64091-91-4)
- N-Nitrososarcosine (CAS 13256-22-9)
- N-Nitrosornicotine (CAS 16543-55-8)
- 3-(N-methylnitrosamino) propionic acid (CAS 10478-42-9)
- 4-(N-methylnitrosamino) butyric acid
- Nitrosoazetidine-4-carboxylic acid (CAS 30248-47-6)
- N-nitrosodiphenylamine (CAS 86-30-6)
- Nitroso-diisopropylamine (CAS 601-77-4)
- N-nitroso N-methyl N phenylamine (CAS 614-00-6)
- N-nitroso N-ethyl N-phenylamine (CAS 612-64-6)
- N-nitroso dibenzylamine (CAS 5336-53-8)
- 1-nitroso-2,3-dihydropyrrole (CAS 37449-28-8)
- N-nitrosodicyclohexylamine (CAS 947-92-2)
- N-nitrosodiisononylamine (CAS 643014-99-7)
- N-Nitrosodimethylamine (NDMA, CAS 62-75-9)
- N-Nitrosodiethylamine (NDEA, CAS 55-18-5)
- N-Nitro-N-methyl-4-aminobutyric acid (NMBA, CAS 61445-55-4)

Issued by an electronic system

2/3

SA TOTAL RESEARCH & TECHNOLOGY FELUY NV

Zone Industrielle C – B-7181 Seneffe (Feluy)

Tél. : +32 (0)64 51 41 11 - Fax. : +32 (0)64 54 08 45 - Courriel : research-feluy@total.com

RPM Charleroi 0438.021.316 - T.V.A. BE 0438.021.316 – BNP Paribas Fortis IBAN BE48 2100 4738 2027 BIC GEBABEBB



Refining & Chemicals

Total Research & Technology Feluy
Regulatory Affairs
Tel. : +32 (0)64 51 40 67
Fax.: +32 (0)64 51 41 49
rc.fer-regaffairs@total.com

GERRESHEIMER Boleslawiec
For the attention of Katarzyna Jawor
Boleslawiec
PL - Poland

- N,N-diethylacetamide (DEA, CAS 685-91-6)
- Triethylamine (CAS 121-44-8)
- Diethylamine (CAS 109-89-7)
- Monoethylamine (CAS 75-04-7)
- Dimethylamine (CAS 124-40-3)
- Trimethylamine (CAS 75-50-3)
- Dibutylamine (CAS 111-92-2)
- Tributylamine (TBA, CAS 102-82-9)
- Tetra Butyl Ammonium Bromide (TBAB, CAS 1643-19-2)3
- N-Methylmorpholine (NMM, CAS 109-02-4)
- N,N-Diisopropylethylamine (DIPEA, CAS 7087-68-5)
- Diethanolamine (CAS 111-42-2)

Feluy, October 31, 2019

POLYPROPYLENE PPC 10712 grade as produced in Europe**Statement of compliance for food contact applications in Europe****1. Commission Regulation (EU) N° 10/2011:**

We confirm that the above-mentioned Product fulfills the harmonized requirements on plastic materials and articles intended to come into contact with food as described in the Regulation (EU) 10/2011 amended up to the Regulation (EU) 2019/1338 and can therefore be lawfully marketed and used throughout the EU, based on the principle of mutual recognition on the following elements:

- All the monomers, polymer production aids and additives used in the Product are included in the Union list in the Regulation (EU) 10/2011 amended up to the Regulation (EU) 2019/1338.
- For other substances (i.e. polymerization aids) used in the Product: they fall outside of the scope of harmonized Regulation (EU) 10/2011. According to article 19 they have been determined to be suitable for their intended use on the basis of the compliance with article 3 of the Framework Regulation (EC) N° 1935/2004 and potentially applicable national Member State Regulation (i.e. Germany – BfR ¹).

Restrictions and/or migration limits:

This Product contains one or more intentionally added substances with a specific migration limit and/or restrictions defined in Annex I of Regulation 10/2011/EU amended up to the Regulation (EU) 2019/1338 and in BfR (¹).

Experimental tests and/or theoretical calculation for migration carried out on the above mentioned Product (or a specimen representative of this material) covering long term storage at room temperature or below, including heating up to 70 °C for up to 2 hours, or heating up to 100°C for up to 15 minutes with aqueous foodstuffs (i.e simulants A and B) and fatty foodstuffs (Single use, polymer used at 100% and thickness up to 250 µm) have shown that the overall and if relevant the specific migration limit was not exceeded with aqueous foodstuffs (i.e simulants A and B) and fatty foodstuffs including metals of annex II.

¹ Gesundheitliche Beurteilung von Kunststoffen im Rahmen des Lebensmittel- und Bedarfsgegenständegesetzes (BfR) : Empfehlung VII: Polypropylen Stand 01.09.2017 – 221 Mitteilung-B. Gesundh.BI.61(2018) 236

Refining & Chemicals

Total Research & Technology Feluy
Regulatory Affairs
Tel. : +32 (0)64 51 40 67
rc.fer-regaffairs@total.com

Page 2/4

CERTIFICATE N° 38689

Feluy, October 31, 2019

POLYPROPYLENE PPC 10712 grade as produced in Europe

For other specific conditions of use, not covered above, it pertains to downstream users to check by appropriate overall and/or specific migration tests on the final material or article the suitability for contact with different food-types, various end-use conditions and different thickness. However these are beyond the control of TOTAL RESEARCH & TECHNOLOGY FELUY and are a part of the responsibility of the user of the above-mentioned Product.

We shall supply the TOTAL REFINING & CHEMICALS proprietary information needed to perform the migration measurements/analyses upon request.

For obtaining more information, please send directly an e-mail to: rc.fer-regaffairs@total.com

Dual use additive:

We inform you that the above-mentioned Product contains one or more substance(s) defined as 'dual use additive(s)'. The downstream user must contact us for additional information and you must inform the downstream user accordingly.

NIAS

Total is well aware of the legal requirements of Regulation 1935/2004/EC and 10/2011/EU, namely materials and articles coming into contact with food shall be manufactured so that they do not transfer their constituents to food in quantities that could endanger human health or bring about unacceptable change to the composition of the food. This does not only include constituents which are intentionally added but also non-intentionally added substances (NIAS)

2. Regulation (EC) N°1935/2004 of the European Parliament & of the Council (Framework Regulation)

We hereby confirm that the above-mentioned Product, when used under normal or foreseeable conditions of use, is expected to meet the relevant requirements laid down in Regulation 1935/2004/EC.

Moreover, we inform you that the organoleptic properties are influenced by the conditions of use i.e. temperature, type of packaged foodstuff, storage conditions. Consequently, the packaging has to be controlled by the downstream user following the specific end-use conditions of use.

Refining & Chemicals

Total Research & Technology Feluy
Regulatory Affairs
Tel. : +32 (0)64 51 40 67
rc.fer-regaffairs@total.com

Page 3/4

CERTIFICATE N° 38689

Feluy, October 31, 2019

POLYPROPYLENE PPC 10712 grade as produced in Europe**3. Commission Regulation (EC) N° 2023/2006 (GMP)**

We inform you that the production of the above-mentioned Product is systematically reviewed with regards to good manufacturing practice (GMP) using our ISO 9001 System, and following the Plastics Europe guideline specifically dedicated to GMP.

Therefore we can state that the above-mentioned Product meets the relevant requirements laid down in Commission Regulation (EC) 2023/2006.

DISCLAIMER:

Our certificate is only valid for as far as above mentioned Product was bought from Total or its distributor and does not cover:

- Any modification of the above-mentioned Product by any addition of any other product or ingredient to it;
- Any prejudicial modification of the above-mentioned Product resulting from a processing of it;
- An inadequate use and/or storage of the above-mentioned Product and/or of the finished articles.

Unless specifically indicated in a regulatory certificate of compliance, the products mentioned herein are not suitable for applications in the pharmaceutical or medical sector. Under no circumstances are any products sold by Total Refining & Chemicals suitable for humans or animals in the following applications: (i) Implantable devices intended for human or animal body (ii) Devices intended to be used in contact with internal body fluids (iii) Devices intended to be used in contact with internal body tissues.

Information contained in this publication is true and accurate at the time of publication and to the best of our knowledge. The nominal values stated herein are obtained using laboratory test specimens. Before using one of the products mentioned herein, customers and other users should take all care in determining the suitability of such product for the intended use.

The Companies within Total Refining & Chemicals do not accept any liability whatsoever arising from the use of this information or the use, application or processing of any product described herein. No information contained in this publication can be considered as a suggestion to infringe patents. The Companies disclaim any liability that may be claimed for infringement or alleged infringement of patents.



Refining & Chemicals

Total Research & Technology Feluy
Regulatory Affairs
Tel. : +32 (0)64 51 40 67
rc.fer-regaffairs@total.com

Page 4/4

CERTIFICATE N° 38689

Feluy, October 31, 2019

POLYPROPYLENE PPC 10712 grade as produced in Europe

The present certificate is valid for a period of eighteen months starting from the date first above written and replaces any earlier certificate relating on this subject which should be considered as null and void. Upon the expiration of this certificate, we can issue a new one at your request. In case of change during this period a new certificate will be issued automatically; kindly forward it to any recipient of the present certificate.

TOTAL RESEARCH & TECHNOLOGY FELUY

C. RAIMOND
Regulatory Affairs

F. RADERMACHER
Regulatory Affairs, Manager

Issued by an electronic system

Refining & Chemicals

Total Research & Technology Feluy
Regulatory Affairs
Tel. : +32 (0)64 51 40 67
rc.fer-regaffairs@total.com

Page 1/2

CERTIFICATE N° 38614

Feluy, October 31, 2019

POLYPROPYLENE PPC 10712 grade as produced in Europe**STATEMENT OF COMPLIANCE FOR FOOD CONTACT IN THE UNITED STATES OF AMERICA**

We confirm that this product fulfils the requirements on materials used for articles or components of articles intended to come into contact with food as described in:

- Code of Federal Regulations Food and Drugs (FDA) Title 21- 2019 - §177.1520: Olefins Polymers ;(a)(3) (i) (c) (1),(b) and (c) 3.1a. The above-mentioned Product or a specimen representative of this material meets the criteria in § 176.170(c) with food types I through IX of table 1, under the conditions of use B through H described in Table 2 of § 176.170(c) of this chapter.

General use conditions (food contact):

It pertains to downstream users of materials intended to come into contact with food, to ensure that the final materials or articles do not bring about an unacceptable change in the composition of the food, or bring about a deterioration in the organoleptic characteristics which render it unfit.

It pertains to downstream users to check by appropriate tests on the final material or article the suitability for contact with different food-types and various end-use conditions. For high temperature applications tests shall be carried out under the worst foreseeable conditions of use in which physical or other changes do not take place and specific precautions must be taken during the end-use in the most severe temperatures to ensure that the polymer remains functional. The maximum testing temperature is governed by the phase transition temperature of the polymer.

DISCLAIMER:

Our certificate is only valid for as far as above mentioned Product was bought from Total or its distributor and does not cover:

- Any modification of the above-mentioned Product by any addition of any other product or ingredient to it;
- Any prejudicial modification of the above-mentioned Product resulting from a processing of it;
- An inadequate use and/or storage of the above-mentioned Product and/or of the finished articles.



Refining & Chemicals

Total Research & Technology Feluy
Regulatory Affairs
Tel. : +32 (0)64 51 40 67
rc.fer-regaffairs@total.com

Page 2/2

CERTIFICATE N° 38614

Feluy, October 31, 2019

POLYPROPYLENE PPC 10712 grade as produced in Europe

Unless specifically indicated in a regulatory certificate of compliance, the products mentioned herein are not suitable for applications in the pharmaceutical or medical sector. Under no circumstances are any products sold by Total Refining & Chemicals suitable for humans or animals in the following applications: (i) implantable devices intended for human or animal body (ii) Devices intended to be used in contact with internal body fluids (iii) Devices intended to be used in contact with internal body tissues.

Information contained in this publication is true and accurate at the time of publication and to the best of our knowledge. The nominal values stated herein are obtained using laboratory test specimens. Before using one of the products mentioned herein, customers and other users should take all care in determining the suitability of such product for the intended use.

The Companies within Total Refining & Chemicals do not accept any liability whatsoever arising from the use of this information or the use, application or processing of any product described herein. No information contained in this publication can be considered as a suggestion to infringe patents. The Companies disclaim any liability that may be claimed for infringement or alleged infringement of patents.

The present certificate is valid for a period of eighteen months starting from the date first above written and replaces any earlier certificate relating on this subject which should be considered as null and void. Upon the expiration of this certificate, we can issue a new one at your request. In case of change during this period a new certificate will be issued automatically; kindly forward it to any recipient of the present certificate.

TOTAL RESEARCH & TECHNOLOGY FELUY

C. RAIMOND
Regulatory Affairs

F. RADERMACHER
Regulatory Affairs, Manager

Issued by an electronic system

Refining & Chemicals

Total Research & Technology Feluy
 Regulatory Affairs
 Tel. : +32 (0)64 51 40 67
 Fax.: +32 (0)64 51 41 49
 rc.fer-regaffairs@total.com

Certificate N° ARP/20L00266
 Page 1 of 8

Letter: ARP/20L00266

Feluy, 11/03/2020

PRODUCT STEWARDSHIP CERTIFICATE
ALL POLYPROPYLENE PPC, PPH, PPM, PPR, PPS, ACESO® AND LUMICENE® PRODUCTS (Manufactured in Europe)
A. ABSENCE OF SUBSTANCES

We hereby confirm that we do not intentionally use the following substances as additive* in the manufacturing of the above-mentioned Products:

1	ALLERGEN SUBSTANCES as listed in Annex II of Regulation (EU) 1169/2011	
2	ANTHRAQUINONE	CAS 84-65-1
3	ANTIMONY TRIOXIDE	CAS 1309-64-4
4	AROMATIC AMINES as listed in Regulation 1907/2006/EC Annex XVII Appendix 8	
5	ASBESTOS as listed in Regulation 1907/2006/EC Annex XVII	
6	AZOCOLORANTS as listed in Regulation 1907/2006 Annex XVII Appendixes 8 and 9	
7	BENZENE	CAS 71-43-2
8	BENZOPHENONE DERIVATIVES	We mean the following substances by benzophenone derivatives : Benzophenone (CAS 119-61-9), 2-hydroxybenzophenone (CAS 117-99-7), 3-hydroxybenzophenone (CAS 13020-57-0), 4-hydroxybenzophenone (CAS 1137-42-4), 4-methylbenzophenone (CAS 134-84-9),
9	BIOCIDAL PRODUCTS as defined in Article 3(1)(a) of the Regulation (EU) No 528/2012	
10	BISPHENOL A, BISPHENOL B, BISPHENOL F and BISPHENOL S	CAS 80-05-7, CAS 77-40-7, CAS 620-92-8 and CAS 80-09-1
11	BHA (ter-Butyl-4-hydroxyanisole)	CAS 25013-16-5
12	BHT (2,6-di-ter-butyl-p-cresol)	CAS 128-37-0

13	CHLORINATED ALIPHATIC COMPOUNDS	We mean the following substances by chlorinated aliphatic compounds: tetrachloromethane (CAS 56-23-5), 1,1,2,2-tetrachloroethane (CAS 79-34-5), 1,1,1,2-tetrachloroethane (CAS 630-20-6), pentachloroethane (CAS 76-01-7), trichloromethane (chloroform; CAS 67-66-3), 1,1,2-trichloroethane (CAS 79-00-5), 1,1-dichloroethylene (CAS 75-35-4), 1,1,1-trichloroethane (CAS 71-55-6).
14	CHLOROFLUOROCARBONS (CFC), HYDROGENATED CHLOROFLUOROCARBONS (HCFC) AND HALONES	
15	CMR SUBSTANCES as listed in Regulation 1272/2008/EC Annex VI	
16	CONFLICT MINERALS (Section 1502 of the Dodd-Frank Wall Street Reform and Consumer Act)	We mean the following substances by conflict minerals: cassiterite, columbite-tantalite, wolframite, tin, tantalum, tungsten and gold
17	COSMETIC prohibited ingredients as listed in Annex II and III of the REGULATION (EC) 1223/2009 on COSMETIC PRODUCTS	
18	DIMETHYLFUMARATE	CAS 624-49-7
19	DIOXINS AND DIFURANS	
20	ENDOCRINE DISRUPTORS category I and II mentioned in Annex 13 of the final report of BKH STUDY 2000	Nevertheless, we inform you that traces of Dibutylphthalate (DBP) may be present in some of our products as catalyst modifier residues. The maximum residue would not exceed 1 ppm.
21	EPOXIDIZED SOYA BEAN OIL (ESBO)	CAS 8013-07-8
22	EPOXY DERIVATIVES Regulation 1895/2005/EC	2,2-bis (4-hydroxyphenyl) propane bis (2,3-epoxypropyl) ether ('BADGE'), bis(hydroxyphenyl) methane bis (2,3-epoxypropyl) ethers ('BFDGE') and novolac glycidyl ethers ('NOGE')
23	ETHANOL	CAS 64-17-5
24	FLAME RETARDANTS	This include Hexabromocyclododecane (HBCD)
25	FORMALDEHYDE	CAS 50-00-0
26	HALOGENS	We mean the following substances by Halogens: Fluorine (CAS 7782-41-4), Chlorine (CAS 7782-50-5), Bromine (CAS 7726-95-6), Iodine (CAS 7553-56-2)
27	HEAVY METALS Directive 94/62/EC and Directive 2004/12/EC	The overall concentration of cadmium, mercury, lead and chromium is lower than 100 ppm (w/w).
28	ISOPROPYLTHIOXANTHONE (ITX)	CAS 5495-84-1 and CAS 83846-86-0
29	LATEX	We mean the following by latex: "a white, tacky, aqueous suspension of a hydrocarbon polymer occurring naturally in some species of trees, shrubs, or plants, or made synthetically".
30	MELAMINE and CYANURIC ACID	CAS 108-78-1 / CAS 108-80-5

31	METALS as listed beside	Nickel, Barium, Cobalt, Arsenic
32	MOSH (Mineral Oil Saturated Hydrocarbons), MOAH (Mineral Oil Aromatic Hydrocarbons), & Mineral Oil	However, we inform you that some trace amount of Mineral Oil can be present in some of here above mentioned products as a manufacturing process residue. This Mineral Oil is included in the Union List of the authorized substances for the manufacturing of plastic materials intended to come into contact with food
33	N_METHYLPYRROLIDONE (NMP)	CAS 872-50-4
34	NONYLPHENOL AND NONYLPHENOLETHOXYLATES as listed in Regulation 1907/2006/EC Annex XVII	
35	ORGANOTIN COMPOUNDS	We mean the following substances by organotin compounds: Monobutyltin compounds (MBT), Dibutyltin compounds (DBT), Dioctyl Tin compounds (DOT), Tributyltin compounds (TBT), Triphenyltin compounds (TPT) and Tributyltin Oxide (TBTO)
36	OZONE-DEPLETING SUBSTANCES - Regulation 1005/2009/EC - The Montreal Protocol on Substances that deplete the Ozone Layer, as last adjusted and/or amended in Montreal 19-2007 (UNEP-United Nation Environment Program) - The United States (Clean Air Act, as amended in 1990, title VI, section 602 (a), class I and II.	CFCs, Halons, Other fully halogenated CFCs, Carbon tetrachloride, 1,1,1-Trichloroethane (Methyl chloroform), Hydrochlorofluorocarbons (HCFC), Hydrobromofluorocarbons (HBFC), Methyl bromide, Bromochloromethane.
37	PARABENS as listed in Annex II and V of the Cosmetic Regulation 1223/2009/EC	
38	PENTACHLOROPHENOL and its salts and esters as listed in Regulation 1907/2006/EC Annex XVII	
39	PERFLUOROCTANE SULFONATE (PFOS) AND PERFLUOROCTANOIC ACID (PFOA)	
40	PESTICIDES, HERBICIDES as defined in Article 2 of the REGULATION (EC) No 1107/2009	
41	PHthalATES	Nevertheless, we inform you that traces of Phthalates may be present in some of our products, as catalyst modifier residues. The maximum residue would not exceed 1ppm.
42	POLYBROMOBIPHENYLS and POLYBROMODIPHENYLETERS - Regulation 1907/2006/EC Annex XVII - Directive 2011/65/EU	This includes penta-, octa-, decabromobiphenylethers.
43	POLYCHLORINATED BIPHENYLS (PCB)	
44	POLYCHLORINATED NAPHTHALENES (PCN)	
45	POLYCHLORINATED TERPHENYLS (PCT) Regulation 1907/2006/EC Annex XVII	

46	POLYCYCLIC AROMATIC HYDROCARBONS (PAH) as listed in Regulation 1907/2006/EC Annex XVII (1272/2013/EC)	
47	POLYVINYLCHLORIDE (PVC), VINYLCHLORIDE MONOMER, POLYVINYLIDENE CHLORIDE (PVDC) VINYLIDENE CHLORIDE MONOMER	
48	POP - Persistent Organic Pollutants As listed in Regulation EU 2019/1021	
49	PROPOSITION 65, January 3, 2020	Chemicals listed in the Proposition 65, California Safe Drinking Water and Toxic Enforcement Act of 1986, dated January 3, 2020 (chemicals list that you can find at the following web address: http://www.oehha.org/prop65/prop65_list/Newlist.html). We can hereby confirm that we do not use the chemicals mentioned in this list as additive*. However, some trace amount of Di-isobutyl phthalate (DIBP) and Dibutyl phthalate (DBP), may be present in some of our products, as catalyst modifier residues.
50	RADIOACTIVE SUBSTANCES as defined in Directive 2013/59/EURATOM	Laying down basic safety standards for the protection of the health of workers and the general public against the dangers arising from ionizing radiation.
51	RECYCLED MATERIALS as defined in Commission Regulation 282/2008/EC	
52	SEMICARBAZIDE and AZODICARBONAMIDE	
53	SHORT CHAINED CHLORINATED PARAFFINS	Short-Chain Chlorinated Paraffins (SCCPs) include all individual chemicals or mixtures that contain: $C_xH_{(2x-y+2)Cl}_y$. Where $x = 10-13$; $y = 3-12$; and the average chlorine content ranges from approximately 40 to 70 percent with the limiting molecular formulas set at $C_{10}H_{19}Cl_3$ and $C_{13}H_{16}Cl_{12}$
54	SILICONE	CAS 63148-53-8, 63394-02-5, 90337-93-2, 63148-62-9
55	STYRENE	CAS 100-42-5
56	TITANIUM ACETYL ACETONATE (TAA)	CAS 77927-72-9
57	TRICLOSAN (2,4,4'-Trichloro-2'-hydroxydiphenyl Ether) Decision 2010/169/EU	CAS 3380-34-5
58	TRIS(NONYLPHENYL) PHOSPHITE (TNPP)	CAS 26523-78-4

* Additive as defined in Regulation (EU) 10/2011

However, since we do not systematically perform specific test to verify the potential presence of these substances in the above-mentioned Products, we cannot guarantee that there is no trace amount of these substances, as impurity or otherwise, in the above-mentioned Products. Moreover, it cannot be excluded that in specific conditions of processing or incineration certain of the above-mentioned substances might be generated as mentioned in the relevant safety data sheet.

B. COMPLIANCE WITH REGULATIONS.**1. CONEG (Coalition of the North-eastern Governors (CONEG, USA))**

The above-mentioned Products meet the requirements of less than 100ppm overall concentration of cadmium, mercury, lead and chromium

2. DECRET 2007-1467 (Article 4) and ENVIRONMENTAL CODE (book V-title IV-chapter III-section V)-dated on 10 November 2008.

We inform you that the "Décret" 98-638 is repealed by article 4 of the French "Décret" 2007-1467 (dated 12 October 2007). We hereby certify that the above-mentioned Products meet the requirements of the article R543-44 item 2b and article R543-45 of Environmental Code (book V) imposing to take into account environmental requirements in the conception and in the manufacturing of packaging material as far as the following articles are concerned:

Article R 543-44 - item 2 (b):

- the above mentioned Products are intended for the manufacture of packaging materials;
- the above-mentioned Products are recyclable by melting and pelletizing;
- the above-mentioned Products have a heat of combustion sufficient to enable to optimize energy recovery (*).

Article R 543-45:

The total of the concentrations of lead + cadmium + mercury + hexavalent chromium does not exceed 100 ppm.

We kindly remind you that the above-mentioned articles of the Code concern the packaging material as end product, for which we cannot provide any guarantee.

(*). The control of the combustion conditions and the technical measures related thereto cannot be controlled by the manufacturer of the above-mentioned Products and thus do not fall within his responsibility."

3. Directive 76/769/EC and Reach Annex XVII

Directive 76/769/EC relating to restrictions on the marketing and use of certain dangerous substances and preparations, established in its Annex I restrictions for certain dangerous substances and preparations. Regulation 1907/2006/EC (Reach Regulation) repealed and replaced Directive 76/769/EC from 1 June 2009 onwards. Annex XVII, published as Regulation 552/2009/EC amending Regulation 1907/2006/EC, replaces Annex I to Directive 76/769/EC. We herewith confirm that the above-mentioned Products comply with Regulation 552/2009/EC.

4. END OF LIFE VEHICLES Directive 2000/53/EC

We hereby confirm that the above-mentioned Products comply with the Directive 2000/53/EC on end of life of vehicles with respect to the heavy metals content limit defined in the notes of the Decision 2002/525/EC because the overall concentration of lead, chromium and mercury is lower than 0.1% by weight, and the concentration of cadmium is lower than 0.01% by weight.

5. GENETICALLY MODIFIED ORGANISMS

For PPH 8025, PPH 9020, PPH 12020, PPR 7220, PPR 7227, PPR 9220, PPR 10231, PPR 10232, PPR 12232, PPR 19R01, Lumicene® MR30MC2, Lumicene® MR60MC2, Lumicene® MR30MX6:

We hereby confirm that we received below indications from our current additive* suppliers :

- 1) The majority of additives* used in the here above mentioned products are not GMO derived
- 2) Whilst the others could derive from Genetically Modified Organism (GMO)

For other Polypropylene products mentioned on page 1, we hereby confirm that we received confirmation of our suppliers of additives* mentioning the absence of genetically modified organisms (GMO).

6. HALAL/KOSHER

We inform you that the above-mentioned products have not received Halal/Kosher certification. However, we can hereby confirm that we do not use, Ethanol (CAS No 64-17-5), as additive (as defined in Regulation (EU) 10/2011) in the here above mentioned products.

7. PACKAGING AND PACKAGING WASTE Directive 94/62/EC:

We hereby confirm that the above-mentioned Products comply with Directive 94/62/EC and Directive 2004/12/EC on Packaging Waste with respect to the heavy metals content limit because the overall concentration of cadmium, mercury, lead and chromium is lower than 100 ppm (w/w)(to be checked for other requirements). In addition, the above-mentioned Products have the potential to be recycled according to these requirements.

8. RoHS II and III Directive 2011/65/EC and 2015/863/EU

We hereby inform you that Directive 2011/65/EU (up to amendment (EU) 2020/366) on the restriction of the use of certain hazardous substances in electrical and electronic equipment (RoHS) does not cover our Polymers as "raw materials" but it only applies to the "electrical and electronic equipment" as finished products defined in the Annex I of Directive 2011/65/EU.

Nevertheless, we hereby confirm that neither Polybromo biphenyls (PBB), Polybromo diphenylethers (PBDE), Bis(2-ethylhexyl) phthalate (DEHP), Butyl benzyl phthalate (BBP), Dibutyl phthalate (DBP), Diisobutyl phthalate (DIBP) are intentionally used in the manufacturing of the above-mentioned Products at a threshold level higher than 0.1%. We confirm that the above-mentioned Products do not contain mercury, lead and hexavalent chromium at a threshold level higher than 0.1% (w/w) each, and of cadmium at a threshold level higher than 0.01% (w/w).

However, since we do not perform specific tests to verify the absence of these substances, we cannot guarantee that there is no trace amount of these substances, as impurity or otherwise, in the above-mentioned product.

9. WASTE ELECTRICAL AND ELECTRONIC EQUIPMENT Directive 2012/19/EU

We hereby inform you that Directive 2012/19/EU (up to amendment (EU) 2018/849) on waste electrical and electronic equipment (WEEE) does not cover our Polymers as "raw materials" but it only applies to the "electrical and electronic equipment" as finished products defined in Article 3 and classified in categories set out in Annex III of Directive 2012/19/EU.

Nevertheless, we hereby confirm that neither Polychlorinated biphenyls (PCB), Polychlorinated terphenyls (PCT), chlorofluorocarbons (CFC), hydrochlorofluorocarbons (HCFC) or hydrofluorocarbons (HFC), brominated flame retardants, asbestos are

intentionally used in the manufacturing of the above-mentioned product at a threshold level higher than 0.1%.

We hereby confirm that the above-mentioned product does not contain mercury, lead and hexavalent chromium at a threshold level higher than 0.1% (w/w) each, and of cadmium at a threshold level higher than 0.01% (w/w).

However, since we do not perform specific tests to verify the absence of these substances, we cannot guarantee that there is no trace amount of these substances, as impurity or otherwise, in the above-mentioned product.

10. SAFETY DATA SHEETS (Regulation 1907/2006/EC)

We recommend before using the above-mentioned Products to carefully read the Safety Data Sheets which can be downloaded from the website: <http://www.polymers.total.com>. Our customers receive automatically a Safety Data Sheet after their first order and when they make a new order after a period that is longer than 12 months. They will also receive automatically a Safety Data Sheet when modifications have been made.

11. TRANSMISSIBLE SPONGIFORM ENCEPHALOPATHY (TSE)

We hereby confirm that we received confirmation of our suppliers of additives* used in the above mentioned products that when substances of animal origin are used, they comply with the requirements stipulated in the *Note for guidance on minimising the risk of transmitting animal spongiform encephalopathy agents via human and veterinary medicinal products* (EMA/410/01 rev.3).

12. VOLATILE ORGANIC COMPOUNDS (VOC)

We hereby inform you that a representative grade of the here above-mentioned product has been analyzed by "Automated Thermal Desorption Gas Chromatography – internal method" for VOC and our results were lower than the threshold concentration pointed out (3% w/w) in Swiss Ordinance on the Incentive Tax on Volatile Organic Compounds (OVOC) of 12 November 1997 (Status as of March 1st, 2013).

* Additive as defined in Regulation (EU) 10/2011

C. NORMS AND STANDARDS

We can hereby confirm that we do not use as additive* any substances listed in these norms and standards above the limit values. The here above mentioned products are plastics and we therefore made reference to the respective parts of these norms and standards.

Furthermore, we inform you that we do not test each grade we sell to check the potential presence of trace amounts of each chemicals hereafter listed which could be present in the here above mentioned products as impurities or otherwise.

- 1. IKEA IOS-MAT-0010** (version AA-10911-15, dated 2019-12-20), **IKEA IOS-MAT-0054** (version AA-92520-11, dated 2018-11-14), **IKEA IOS-MAT-0195** (version AA-2208470-2, dated 2020-01-20), **IKEA IOS-PRG-0021** (version AA-31847-7, dated 2011-10-14).
- 2. GADSL - GLOBAL AUTOMOTIVE DECLARABLE SUBSTANCE List – 2019**

* Additive as defined in Regulation (EU) 10/2011

Refining & Chemicals

Total Research & Technology Feluy
Regulatory Affairs
Tel. : +32 (0)64 51 40 67
Fax.: +32 (0)64 51 41 49
rc.fer-regaffairs@total.com

Certificate N° ARP/20L00266
Page **8** of **8**

Our certificate does not cover:

- any modification of The Product by any addition of any other product to it,
- any prejudicial modification of The Product resulting from a processing of The Product,
- an inadequate use and/or storage of The Product and of the finished articles.

Information contained in this publication is true and accurate at the time of publication and to the best of our knowledge. The present certificate is based on the status of the legislation at the date written above and is valid until **end of August 2021**. This certificate cancels and supersedes any prior version thereof. It can be renewed upon request.

We are at your disposal for any further information you may need and remain,

Yours faithfully,
Total Research & Technology Feluy

B. KLUYSKENS
Regulatory Affairs

F. RADERMACHER
Regulatory Affairs, Manager

Refining & Chemicals

Total Research & Technology Feluy
Regulatory Affairs
Tel. : +32 (0)64 51 40 67
Fax.: +32 (0)64 51 41 49
rc.fer-regaffairs@total.com

GERRESHEIMER Boleslawiec
For the attention of Katarzyna Jawor
Boleslawiec
PL - Poland

Letter: ARP/20L00398

Feluy, 23/03/2020

Dear Madam,

Concern: POLYPROPYLENE PPC 10712, POLYPROPYLENE PPH 10012

NITROSAMINES (EMA/189634/2019)

This statement is in response to your request regarding the Nitrosamines impurities as mentioned in EMA/189634/2019 from the European Medicines Agency (EMA) in the here above-mentioned product. In September 2019 EMA began a review under Article 5(3) of Regulation (EC) No 726/2004 to provide guidance to marketing authorisation holders on how to avoid the presence of nitrosamine impurities in human medicines.

We can hereby confirm that we do not intentionally use the substances listed below in the manufacturing of here above-mentioned product.

We hereby inform you that to the best of our knowledge nitrosamines compounds would not be present in the here above-mentioned product sold and supplied by Total Refining & Chemicals.

However, we inform you that some traces of amines (primary, secondary or tertiary), at a ppb level, may be present in the here above-mentioned product.

However, since we do not perform specific tests to verify the potential presence of nitrosamines compounds, amines, nitrosating agents and substances listed in the here above-mentioned product, we cannot guarantee that there is no trace amount of some of nitrosamines compounds, amines, nitrosating agents and substances listed below as impurity or otherwise, in the here above-mentioned product.

Our certificate does not cover :

- any modification of the warranted product by any addition of any other product to it,
- any prejudicial modification of the warranted product resulting from a processing of the product,
- an inadequate use and/or storage of the material and of the finished articles.

The present certificate is valid for a period of one year starting from the date first above written. It can then be renewed upon request.

We are at your disposal for any further information you may need and remain,

Yours faithfully,
Total Research And Technology Feluy

B. KLUYSKENS
Regulatory Affairs

F. RADERMACHER
Regulatory Affairs, Manager

Issued by an electronic system

1/3

SA TOTAL RESEARCH & TECHNOLOGY FELUY NV

Zone Industrielle C – B-7181 Seneffe (Feluy)

Tél. : +32 (0)64 51 41 11 - Fax. : +32 (0)64 54 08 45 - Courriel : research-feluy@total.com

RPM Charleroi 0438.021.316 T.V.A. BE 0438.021.316 – BNP Paribas Fortis IBAN BE48 2100 4738 2027 BIC GEBABEBB

Refining & Chemicals

Total Research & Technology Feluy
Regulatory Affairs
Tel. : +32 (0)64 51 40 67
Fax.: +32 (0)64 51 41 49
rc.fer-regaffairs@total.com

GERRESHEIMER Boleslawiec
For the attention of Katarzyna Jawor
Boleslawiec
PL - Poland

List of Substances:

- Sodium Nitrite (NaNO₂, CAS 7632-00-0)
- Nitrocellulose (EC 936-908-7)
- Ozone (CAS 10028-15-6)
- Nitrous Acid (HNO₂, CAS 7782-77-6)
- Nitric Acid (HNO₃, CAS 7782-77-6)
- Nitric Oxid (NO, CAS 10102-43-9)
- Nitrosyl halides (e.g. ClNO, BrNO)
- Dinitrogen trioxide (N₂O₃, CAS 10544-73-7)
- Dinitrogen tetroxide (N₂O₄, CAS 10544-72-6);
- Organic nitrites (e.g. t-BuONO)
- Formaldehyde (CAS 50-00-0)
- Amide solvents
- N,N-dimethylformamide (DMF, CAS 68-12-2)
- N-Methylpyrrolidone (NMP, CAS 120-94-5)
- N,N-dimethylacetamide (DMA, CAS 127-19-5)
- Hydroxylamine (NH₂OH, CAS 7803-49-8)
- N-nitro-N-methyl-4-aminobutyric acid (NMBA, CAS 61445-55-4)
- N-nitrosodimethylamine (NDMA, CAS 62-75-9)
- N-nitrosométhyléthylamine (CAS 10595-95-6)
- N-nitrosodiethylamine (NDEA, CAS 55-18-5)
- N-nitrosodipropylamine (CAS 621-64-7)
- N-nitrosodibutylamine (CAS 924-16-3)
- N-nitrosomorpholine (CAS 59-89-2)
- N-nitrosopiperidine (CAS 100-75-4)
- N-nitrosopyrrolidine (CAS 930-55-2)
- N-nitrosodiethanolamine (CAS 1116-54-7)
- N-Methyl-N'-Nitro-N-Nitrosoguanidine (CAS 70-25-7)
- N-Nitrosoethyl-n-butylamine (CAS 4549-44-4)
- N'-Nitrosoanabasine (CAS 37620-20-5)
- 4-(Methylnitrosamino)-1-(3-pyridyl)-1-butanol (CAS 76014-81-8)
- 4-(Methylnitrosamino)-1-(3-pyridyl)-1-butanone (CAS 64091-91-4)
- N-Nitrososarcosine (CAS 13256-22-9)
- N-Nitrosornicotine (CAS 16543-55-8)
- 3-(N-methylnitrosamino) propionic acid (CAS 10478-42-9)
- 4-(N-methylnitrosamino) butyric acid
- Nitrosoazetidine-4-carboxylic acid (CAS 30248-47-6)
- N-nitrosodiphenylamine (CAS 86-30-6)
- Nitroso-diisopropylamine (CAS 601-77-4)
- N-nitroso N-methyl N phenylamine (CAS 614-00-6)
- N-nitroso N-ethyl N-phenylamine (CAS 612-64-6)
- N-nitroso dibenzylamine (CAS 5336-53-8)
- 1-nitroso-2,3-dihydropyrrole (CAS 37449-28-8)
- N-nitrosodicyclohexylamine (CAS 947-92-2)
- N-nitrosodiisononylamine (CAS 643014-99-7)
- N-Nitrosodimethylamine (NDMA, CAS 62-75-9)
- N-Nitrosodiethylamine (NDEA, CAS 55-18-5)
- N-Nitro-N-methyl-4-aminobutyric acid (NMBA, CAS 61445-55-4)

Issued by an electronic system

2/3

SA TOTAL RESEARCH & TECHNOLOGY FELUY NV

Zone Industrielle C – B-7181 Seneffe (Feluy)

Tél. : +32 (0)64 51 41 11 - Fax. : +32 (0)64 54 08 45 - Courriel : research-feluy@total.com

RPM Charleroi 0438.021.316 - T.V.A. BE 0438.021.316 – BNP Paribas Fortis IBAN BE48 2100 4738 2027 BIC GEBABEBB



Refining & Chemicals

Total Research & Technology Feluy
Regulatory Affairs
Tel. : +32 (0)64 51 40 67
Fax.: +32 (0)64 51 41 49
rc.fer-regaffairs@total.com

GERRESHEIMER Boleslawiec
For the attention of Katarzyna Jawor
Boleslawiec
PL - Poland

- N,N-diethylacetamide (DEA, CAS 685-91-6)
- Triethylamine (CAS 121-44-8)
- Diethylamine (CAS 109-89-7)
- Monoethylamine (CAS 75-04-7)
- Dimethylamine (CAS 124-40-3)
- Trimethylamine (CAS 75-50-3)
- Dibutylamine (CAS 111-92-2)
- Tributylamine (TBA, CAS 102-82-9)
- Tetra Butyl Ammonium Bromide (TBAB, CAS 1643-19-2)3
- N-Methylmorpholine (NMM, CAS 109-02-4)
- N,N-Diisopropylethylamine (DIPEA, CAS 7087-68-5)
- Diethanolamine (CAS 111-42-2)

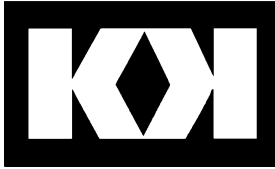

kunststof
kemi a/s

Ringvejen 70
DK-7900 Nykøbing Mors
Phone: +45 97 72 27 11
E-mail: regulatory@kunststof-kemi.com

Issue date: 12.03.2021
Version: 4-1 / LSH

Statement:

RE: 1935/2004

Regulation (EC) No. 1935/2004 of the European Parliament and of the Council dated 27th October 2004 **is a framework regulation** covering all materials and articles intended to come in contact with food.

This regulation supersedes the framework regulations 80/590/EEG and 89/109/EEC and specifies **general requirements** for all materials and articles intended to come in contact food, such as glass, paper, metal, plastics etc.

According to Article 5 and Annex 1 of the Regulation No. 1935/2004/EC, certain groups of materials and articles, listed in Annex 1, among which **plastics are subject to specific measures**.

For plastic materials and articles intended to come in contact with foodstuffs, these specific measures are laid down in the Commission Regulation (EU) No. 10/2011 on plastics materials and articles intended to come into contact with food published in the Official Journal of the European Union on 14 January 2011 (this Regulation replaces Directive 2002/72/EC and its amendments) and its amendments.

RE: 10/2011

Regulation (EU) No. 10/2011 on plastics materials and articles intended to come into contact with food published in the Official Journal of the European Union on 14 January 2011 and its amendments

First, we wish to point out that the scope of the Commission Regulation (EU) No. 10/2011 on plastics materials and articles intended to come into contact with food and its amendments is the final product, not the ingredients of same; consequently, it is incumbent on the end producer to test for specific migration and "over all" migration.

Pigments:

Also, it should be mentioned that the regulation does not treat the pigments in the master-batches, only of the polymer and the additives.

As outlined in Article 5 of the regulation, pigments are not within the scope of the regulation:

2. The Union list shall contain
 - (b) Additives excluding colorants

Furthermore is mention in Article 6:

2. By way of derogation from Article 5, colorants and solvents may be used in the manufacture of plastic layers in plastic materials and articles subject to national law.

The pigment applied in 20-2060-PW-6 meets the purity requirements of EU Resolution AP (89) 1: "On the Use of Colourants in Plastic Materials Coming into Contact with Food".

*20-2060-PW-6 contains Pigment White 6 which might contain 1,1,1-Trimethylolpropane (FCM-No. 141) which has got a Specific Migration Limit: SML = 6 mg/kg.
(Pigment supplier recommendation: SML = 4.2 mg/kg)
20-2060-PW-6 might contain approx. 0.16 % TMP.*

*20-2060-PW-6 contains Pigment White 6 which contains Aluminium.
General restrictions listed in the Annex II of Regulation (EU) No 10/2011:
Aluminium has got a Specific Migration Limit: SML = 1 mg/kg.*

Dual Use Additives:

20-2060-PW-6 contains the following migrating "dual use" additive added by Kunststoff-Kemi: Calcium stearate.

20-2060-PW-6 might contain a polymer which contains the following "dual use" additives: Glycerin (E422), Calcium salts of fatty acids (E470a), Glyceryl monostearate (E471) and Stearic acid (E570).

Polymers:

20-2060-PW-6 is based on polymers produced from monomers that are all detailed in the positive list of the Commission Regulation (EU) No. 10/2011 on plastics materials and articles intended to come into contact with food and its amendments.

Additives:

The additives contained in 20-2060-PW-6 are listed in the Commission Regulation (EU) No. 10/2011 on plastics materials and articles intended to come into contact with food and its amendments.

20-2060-PW-6 might contain a polymer which contains the following additives / elements with a Specific Migration Limit:

12H-Dibenzo[d,g][1,3,2]dioxaphosphocin, 2,4,8,10-tetrakis(1,1-dimethylethyl)-6-hydroxy-, 6-oxide, lithium salt (CAS# 85209-93-4) which has got a Specific Migration Limit: SML = 5 mg/kg.

9,9-bis(methoxymethyl)fluorine (CAS# 182121-12-6) which has got a Specific Migration Limit: SML = 0.05 mg/kg.

N,N-Bis(2-hydroxyethyl)alkyl(C13-C15)amine (CAS# 70955-14-5) which has got a Specific Migration Limit: SML(T) = 1.2 mg/kg.

*Aluminium - General restrictions listed in the Annex II of Regulation (EU) No 10/2011:
Aluminium has got a Specific Migration Limit: SML = 1 mg/kg.*

*Lithium - General restrictions listed in the Annex II of Regulation (EU) No 10/2011:
Lithium has got a Specific Migration Limit: SML = 0.6 mg/kg.*

Additives added by Kunststoff-Kemi with a Specific Migration Limit:

20-2060-PW-6 contains:

Approx. 0.05 % 3,5-di-tert-butyl-4-hydroxybenzylphosphonic acid, monoethyl ester, calcium salt (Ref. No. 46880) which has got a Specific Migration Limit: SML = 6 mg/kg.

Another aspect of the Commission's Regulation (EU) No. 10/2011 on plastics materials and articles intended to come into contact with food and its amendments is the specific and the overall migration

- 1) As from 1 January 2016, the supporting documents referred to in Article 16 of Regulation (EU) No. 10/2011 shall be based on the rules for migration testing set out in Article 18 of Regulation (EU) No. 10/2011, without prejudice to paragraph 2 of this Article.

According to the Commission Regulation (EU) No. 10/2011 on plastics materials and articles intended to come into contact with food and its amendments the finished plastic material and articles shall not release

- 1) Primary aromatic amines excluding those appearing in Table 1 of Annex I in a detectable quantity (DL = 0.01 mg/kg of food or food simulant).
- 2) The following substances in quantities exceeding the specific migration limits below:
 - Aluminium = 1 mg/kg food or food simulant
 - Barium = 1 mg/kg food or food simulant
 - Cobalt = 0.05 mg/kg food or food simulant
 - Copper = 5 mg/kg food or food simulant
 - Iron = 48 mg/kg food or food simulant
 - Lithium = 0.6 mg/kg food or food simulant
 - Manganese = 0.6 mg/kg food or food simulant
 - Nickel = 0.02 mg/kg food or food simulant
 - Zinc = 5 mg/kg food or food simulant

Consequently, it rests with the producer of the finished product to analyse for possible release of primary aromatic amines + the above mentioned metals and not with the masterbatch producer (masterbatch being a semi-finished product).

Kunststof-Kemi cannot guarantee whether or not a compound produced from 20-2060-PW-6 will be in conformity with the requirements as stipulated in the Commission Regulation (EU) No. 10/2011 on plastics materials and articles intended to come into contact with food and its amendments, because Kunststof-Kemi would not know the further processing parameters. Kunststof-Kemi has not determined whether a compound produced from 20-2060-PW-6 will be in conformity with the limits as described in the Commission Regulation (EU) No. 10/2011 on plastics materials and articles intended to come into contact with food and its amendments.

Supplementary Information:

Since the masterbatch producer cannot be responsible for the subsequent use of his product, the responsibility to test if the final product complies with the national and international provisions and laws rests with the producer of the finished product. This product information is based on the present state of our knowledge, information and experience. No responsibility or liability can be assumed for factors lying outside our knowledge and control.

RE: 2023/2006/EC

Kunststof-Kemi is certified according to the Quality Management System standard: ISO 9001:2015. Hence we find that we fulfil the requirements in EU directive 2023/2006 of 22th December 2006 on good manufacturing practice for materials and articles intended to come into contact with food.

Product Stewardship
Kunststof-Kemi Skandinavia A/S

This document is valid without signature

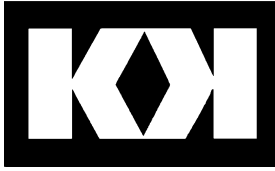

kunststof
kemi a/s

Ringvejen 70
DK-7900 Nykøbing Mors
Phone: +45 97 72 27 11
E-mail: regulatory@kunststof-kemi.com

Issue date: 08.02.2019
Version: 1 / LSH

Statement:

RE: Allergens

Kunststof-Kemi hereby declare that

- The food ingredients listed in Annex II of Regulation (EU) No 1169/2011 of the European Parliament and of the Council of 25 October 2011 on the provision of food information to consumers

are not intentionally added to the 20-2060-PW-6 and to our best knowledge these substances are not present in the supplied product. However, this product have not been tested for these substances.

Please note that we do not carry out specific analyses to this effect but base our statement on our current knowledge of the composition, raw materials and production technology. However, please be aware that our products should be considered large volume industrial products and that the presence of traces of ubiquitous substances cannot be excluded.

Supplementary Information:

Since the masterbatch producer cannot be responsible for the subsequent use of his product, the responsibility to test if the final product complies with the national and international provisions and laws rests with the user of the masterbatch. This product information is based on the present state of our knowledge, information and experience. No responsibility or liability can be assumed for factors lying outside our knowledge and control.

Product Stewardship
Kunststof-Kemi Skandinavia A/S

This document is valid without signature

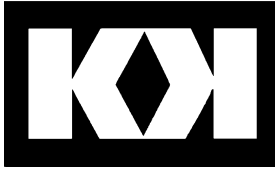

kunststof
kemi a/s

Ringvejen 70
DK-7900 Nykøbing Mors
Phone: +45 97 72 27 11
E-mail: regulatory@kunststof-kemi.com

Issue date: 08.02.2019
Version: 1 / LSH

Statement:

RE: Substances of animal origin

Kunststof-Kemi hereby declare that

- Substances of animal origin

are not intentionally added to the 20-2060-PW-6 and to our best knowledge these substances are not present in the supplied product.

Please note that we do not carry out specific analyses to this effect but base our statement on our current knowledge of the composition, raw materials and production technology. However, please be aware that our products should be considered large volume industrial products and that the presence of traces of ubiquitous substances cannot be excluded.

Supplementary Information:

Since the masterbatch producer cannot be responsible for the subsequent use of his product, the responsibility to test if the final product complies with the national and international provisions and laws rests with the user of the masterbatch. This product information is based on the present state of our knowledge, information and experience. No responsibility or liability can be assumed for factors lying outside our knowledge and control.

Product Stewardship
Kunststof-Kemi Skandinavia A/S

This document is valid without signature

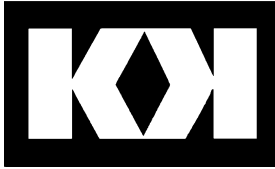

kunststof
kemi a/s

Ringvejen 70
DK-7900 Nykøbing Mors
Phone: +45 97 72 27 11
E-mail: regulatory@kunststof-kemi.com

Issue date: 08.02.2019
Version: 1 / LSH

Statement:

RE: Bisphenol A

Kunststof-Kemi hereby declare that

- Bisphenol A

is not intentionally added to 20-2060-PW-6 and to our best knowledge this substance is not present in the supplied product.

Please note that we do not carry out specific analyses to this effect but base our statement on our current knowledge of the composition, raw materials and production technology. However, please be aware that our products should be considered large volume industrial products and that the presence of traces of ubiquitous substances cannot be excluded.

Supplementary Information:

Since the masterbatch producer cannot be responsible for the subsequent use of his product, the responsibility to test if the final product complies with the national and international provisions and laws rests with the user of the masterbatch. This product information is based on the present state of our knowledge, information and experience. No responsibility or liability can be assumed for factors lying outside our knowledge and control.

Product Stewardship
Kunststof-Kemi Skandinavia A/S

This document is valid without signature

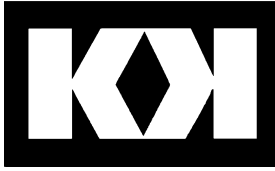

kunststof
kemi a/s

Ringvejen 70
DK-7900 Nykøbing Mors
Phone: +45 97 72 27 11
E-mail: regulatory@kunststof-kemi.com

Issue date: 08.02.2019
Version: 1 / LSH

Statement:

RE: Latex

Kunststof-Kemi hereby declare that

- Latex

are not intentionally added to 20-2060-PW-6 and to our best knowledge these substances are not present in the supplied product.

Please note that we do not carry out specific analyses to this effect but base our statement on our current knowledge of the composition, raw materials and production technology. However, please be aware that our products should be considered large volume industrial products and that the presence of traces of ubiquitous substances cannot be excluded.

Supplementary Information:

Since the masterbatch producer cannot be responsible for the subsequent use of his product, the responsibility to test if the final product complies with the national and international provisions and laws rests with the user of the masterbatch. This product information is based on the present state of our knowledge, information and experience. No responsibility or liability can be assumed for factors lying outside our knowledge and control.

Product Stewardship
Kunststof-Kemi Skandinavia A/S

This document is valid without signature

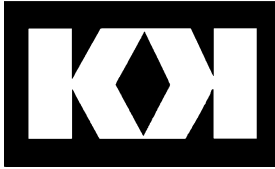

kunststof
kemi a/s

Ringvejen 70
DK-7900 Nykøbing Mors
Phone: +45 97 72 27 11
E-mail: regulatory@kunststof-kemi.com

Issue date: 08.02.2019
Version: 1 / LSH

Statement:

RE: Absence of various substances

We hereby declare that

- Melamine

are not intentionally added by Kunststof-Kemi during production of 20-2060-PW-6.

Please note that we do not carry out specific analyses to this effect but base our statement on our current knowledge of the composition, raw materials and production technology. However, please be aware that our products should be considered large volume industrial products and that the presence of traces of ubiquitous substances cannot be excluded.

Supplementary Information:

Since the masterbatch producer cannot be responsible for the subsequent use of his product, the responsibility to test if the final product complies with the national and international provisions and laws rests with the user of the masterbatch. This product information is based on the present state of our knowledge, information and experience. No responsibility or liability can be assumed for factors lying outside our knowledge and control.

Product Stewardship
Kunststof-Kemi Skandinavia A/S

This document is valid without signature

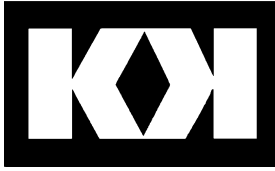

kunststof
kemi a/s

Ringvejen 70
DK-7900 Nykøbing Mors
Phone: +45 97 72 27 11
E-mail: regulatory@kunststof-kemi.com

Issue date: 08.02.2019
Version: 1 / LSH

Statement:

RE: Phthalates

Phthalates are not intentionally added to the 20-2060-PW-6 by Kunststof-Kemi, but 20-2060-PW-6 contains polypropylene which might contain traces of phthalates.

Our raw material supplier states:

"The polyolefins do not require the use of plasticizers (such as phthalates) to make them soft and flexible. The polymer producer does not add phthalates to its polyolefin products as plasticizers. However, traces of phthalates may be present in the product as impurities from the catalytic system."

Please note that we do not carry out specific analyses to this effect but base our statement on our current knowledge of the composition, raw materials and production technology.

Supplementary Information:

Since the masterbatch producer cannot be responsible for the subsequent use of his product, the responsibility to test if the final product complies with the national and international provisions and laws rests with the user of the masterbatch. This product information is based on the present state of our knowledge, information and experience. No responsibility or liability can be assumed for factors lying outside our knowledge and control.

Product Stewardship
Kunststof-Kemi Skandinavia A/S

This document is valid without signature



Product information / Produktinformation
Ultrabatch

Product / Produkt	20-2060-PW-6
Supplied as / Lieferform	Granules / Granulat
Ingredient / Bestandteile Pigments / Pigmente	Pigment White 6
Pigment content / Pigmentgehalt	Appr./ Ca. 60 %
Carrier / Träger	PP
Heat resistance / Temperaturbeständigkeit	300 °C
Light fastness / Lichtechtheit	8
Weathering fastness / Wetterechtheit	5
Migration resistance / Migrationsbeständigkeit	5
Test Method / Testmethode	Visual Control / Visuelle Kontrolle
Heavy metals content / Gehalt an Schwermetallen	Pb+Cd+Hg+Cr(VI) < 100 ppm
Suitable for food contact application / Geignet für Lebensmittelverpackungen	+

According to the German BfR Recommendation No.IX and VII and the FDA CFR 21 § 177.1520 and CFR 21 § 178.3297 the ingredients of the above product are suitable for colouring of plastics to be applied in contact with food. We wish to point out, however, that our responsibility as masterbatch producers cannot be extended to include the application to which our product is put by the manufacturer. In principle, therefore, the manufacturer applying our masterbatch will be responsible for testing the finished product in contact with food for its possible influence on the taste and smell of the food product. Particularly, when applied to packaging and storage of sensitive foodstuffs, like milk for instance, the plastic material should be tested for its possible effects on the food product.

Gemäss der Empfehlung IX und VII des BfR und den FDA CFR 21 § 177.1520 und CFR 21 § 178.3297 sind die Bestandteile im obigen Produkt für Lebensmittelverpackungen und Bedarfsgegenstände einsetzbar. Da wir aber als Hersteller auf die spätere Verarbeitung des Masterbatches keinen Einfluss haben, ist der Verarbeiter selbst gehalten, die Farblässigkeit praxisnah dem Endprodukt zu prüfen. Darüber hinaus dürfen die Lebensmittel weder geruchlich noch geschmacklich beeinflusst werden. Besonders bei der Verpackung empfindlicher Lebensmittel wie z.B. Milch sind daher sorgfältige Prüfungen unerlässlich.

From: Lise Kølsten Kristensen, Kunststof-Kemi A/S <lise@kunststof-kemi.com>

Sent: Monday, February 24, 2020 11:44 AM

To: Jawor, Katarzyna <katarzyna.jawor@gerresheimer.com>

Subject: VS: Nitrosamines statement for 20-2060-PW-6

Dear Katarzyna

Sorry about my delay in getting back to you. I have received following feed-back from my colleagues:

“Nitrosamines are chemical compounds of the chemical structure $R1-N(-R2)-N=O$, a nitroso group bonded to an amine.

Nitrosamines are not intentionally added by Kunststof-Kemi during production of 20-2060-PW-6.

Please note - Analysis has not been conducted to confirm the absence of the above mentioned substances but base our statement on our current knowledge of the composition, raw materials and production technology.

However, please be aware that our products should be considered large volume industrial products and that the presence of traces of ubiquitous substances cannot be excluded.

Downstream, we cannot know every possible byproduct developed by working with the pigments/SPD's, because it depends on pigments structure, how the pigments are treated, regarding temperature, processes, UV-exposure, use in regenerated polymers with contamination, crosslinking (peroxides) and more. All parameters that Kunststof-Kemi cannot know.”

I hope the above will help you.

Let me know if you have any comments.

Thanks.



TEST REPORT

Client

Gerresheimer Vaerloese
Walgerholm 2-8
DK-3500 Vaerloese
Denmark

Gregersensvej
DK-2630 Taastrup
Telephone +45 72 20 20 00
Telefax +45 72 20 20 19

Report No 715870/1
Req. no: 10174
1347624
29 September 2016
HEAN

info@teknologisk.dk
www.teknologisk.dk

Specifications

Closure

Type: Duma Cap
Type: Duma Pocket Base
Number: 05016B-0000
Raw material: PPC10712 (PP)
Colour: White, 20-2060-PW-6 (PP)
Cavity: 9-20 (Mould 2)

Container

Type: Duma Pocket 50 ml
Number: 05016A-0000
Raw material: 50% PPC10712 & 50% PPH10012 (PP)
Colour: White, 20-2060-PW-6 (PP)
Cavity: 13-20 (Mould 3)

Test period: 14 September - 28 September 2016

Classification: Moisture Vapour Transmission

10 specimens of containers and closures have been tested according to USP 39 <671>. Classification for packaging systems, the containers so tested are *tight containers* if not more than one of the 10 test containers exceeds 100 mg per day per litre in moisture vapour transmission, and none exceeds 200 mg per day per litre. Packaging systems are *well closed* if not more than one of the 10 test containers exceeds 2000 mg per day per litre in moisture vapour transmission, and none exceeds 3000 mg per day per litre.

The work has been carried out according to the General Terms and Conditions regarding commissioned work accepted by the Danish Technological Institute.

Results

mg water vapour per day per litre container-volume:

No 1	No 2	No 3	No 4	No 5	No 6	No 7	No 8	No 9	No 10
11.9	7.7	13.8	12.3	7.1	10.2	14.2	10.4	14.4	7.7

Average: 11.0 mg/d/l

Conclusion

The tested containers comply with the classification of USP 39 <671> test for tight containers.

Centre: Packaging and Logistics

Helle Antvorskov, Senior Consultant
Phone: +45 72 20 31 69
e-mail: hean@dti.dk

Test responsible

Helle Allermann, Senior Consultant
Phone: +45 72 20 31 63
e-mail: heal@dti.dk

Co-reader



TEST REPORT

Client

Gerresheimer Vaerloese
Walgerholm 2-8
DK-3500 Vaerloese
Denmark

Report No 696714/1
Req. no: 9638
3 May 2016
1347624
HEAL

Specifications

Closure

Type: Duma Pocket 50 ml
Number: 05016A-0000
Raw material: 50% PPH 10012 and 50% PPC 10712
Colour: 20-2060-PW-6

Closure

Date of receipt: 2 May 2016
Test period: 3 May 2016

Light Transmission

Closure has been tested according to USP 39 <671> - according to test requirements for containers.

Requirement: The light transmission must not exceed 10 % in the range from 290 to 450 nm. Enclosure 1 shows the spectra from 290 to 450 nm of the samples from the closure.

Results

maximum % light transmission:

Sample No 1	Sample No 2
2.6	2.6

Conclusion

The tested closure complies with the requirement of USP 39 <671>.

Centre: Packaging and Logistics

Helle Allermann, Senior Consultant
Phone: +45 72 20 31 63
e-mail: heal@dti.dk

Test responsible

Søren R. Østergaard, Head of Section Packaging
Phone: +45 72 20 31 80
e-mail: sos@dti.dk

Co-reader

Gerresheimer Vaerloese

Type: Duma Pocket 50 ml
Number: 05016A-0000

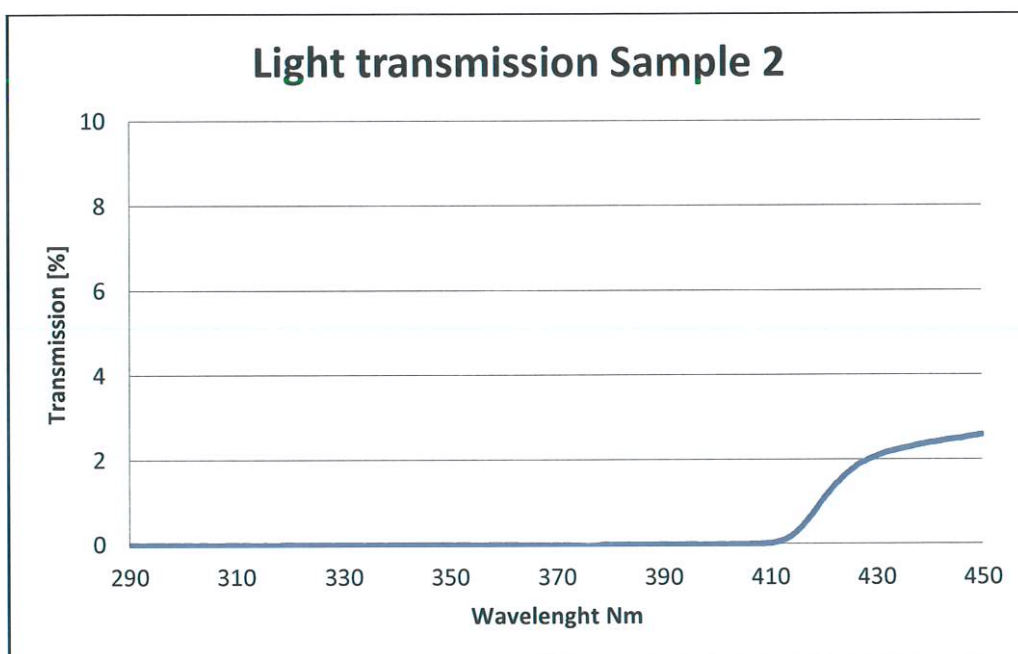
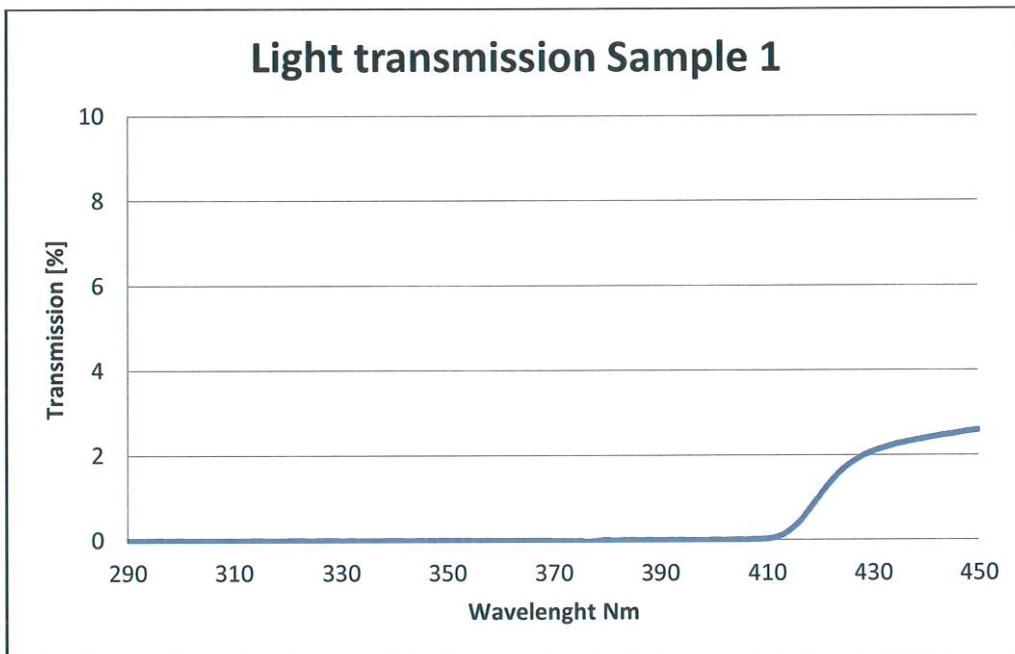

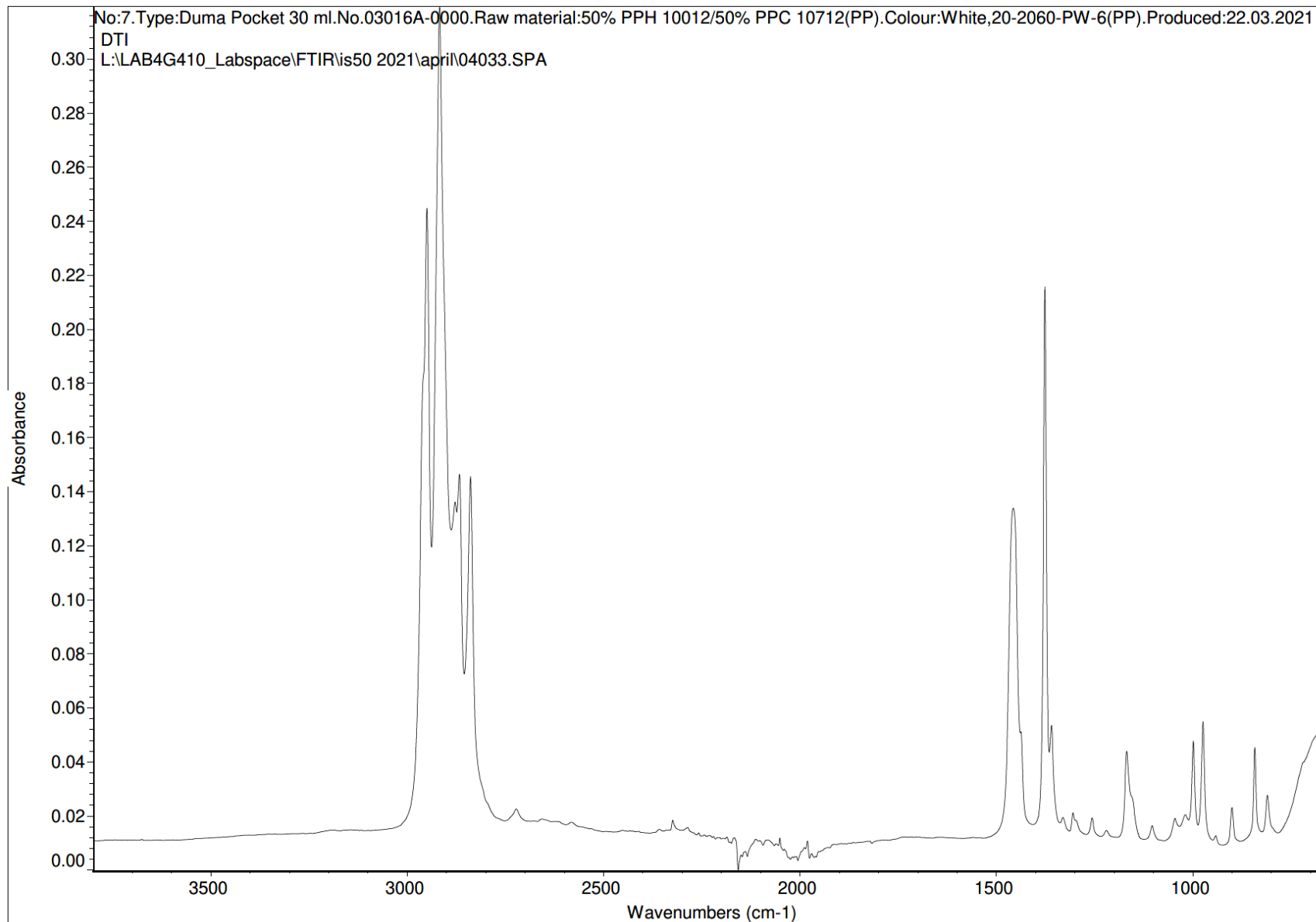

1 August 2016
ten-decrGregersensvej
DK-2630 Taastrup
Tel. +45 72 20 20 00
Fax +45 72 20 20 19info@teknologisk.dk
www.teknologisk.dk

Test report

Customer

Gerresheimer Vaerloese A/S
Walgerholm 2-8
DK-3500 Vaerloese

Rep. no.: 139/16-3

Page: 1 of 2

No. of encl.: 1

Cosign: *Ten*

Test

Thermal analysis

Sample

Raw material sent to our laboratory on 22 June 2016 bearing the following ID

DSC sample no. 3

Raw material: HF840MO (PP)

Batch no.: B1-60075

DSC sample no. 4

Raw material: PPH 10012 (PP)

Batch no.: 630272

DSC sample no. 5

Raw material: PPC 10712 (PP)

Batch no.: 630158

Test method

The DSC (thermal analysis) is based on

USP 39 <661> *Containers - Plastics / Physical Tests*, which refers to
USP 39 <891> *Thermal Analysis*One spot sample (approx. 12 mg) was taken from the raw material.
The following conditions were used for the comparative DSC analysis:

Heating 25 °C to +200 °C at 10 °C/min in nitrogen (80 ml/min)

Hold the temperature for 10 min at 200 °C

Cooling 200 °C to 110 °C at 10°C/min in nitrogen (80 ml/min)

The peak values of the Onset temperature are compared.

Test equipment

32T07.02 Calorimeter, Differential Scanning Calorimetry, DSC 823e from Mettler-Toledo
32T14.60 Analytical balance XS 105 from Mettler-Toledo
32T07.03 Reference sample of polypropylene from USP (Rockville)
Purge gas Nitrogen (purity grading: 5) from Aga

Test results

Sample	Melting Peak °C	Onset °C	Difference between values (Onset temperature) °C
Ref sample of polypropylene	166.0	153.7	-
DSC sample no. 3 Raw material: HF840MO (PP) Batch no.: B1-60075	168.5	154.8	1.1
DSC sample no. 4 Raw material: PPH 10012 (PP) Batch no.: 630272	168.0	153.7	0
DSC sample no. 5 Raw material: PPC 10712 (PP) Batch no.: 630158	169.1	154.8	1.1

Acceptance criteria: Difference between values (Onset temperature) ≤ 12.0 °C

Test result: *Pass*

Yours sincerely
Centre for Plastics Technology



Tina Elmer Nielsen
Laboratory Technician

Phone: +45 72 20 31 13 (direct)
Email: ten@teknologisk.dk

Conditions: The test results are solely referring to the tested (examined) materials. The testing has been performed in compliance with an accreditation from the Danish Accreditation Scheme.
Enclosed are the General Terms and Conditions regarding Commissioned Work accepted by the Danish Technological Institute (DTI)
Publication of the Test Report in full is allowed. Publication of extracts from the Test Report is allowed, if the testing laboratory has given a written approval.

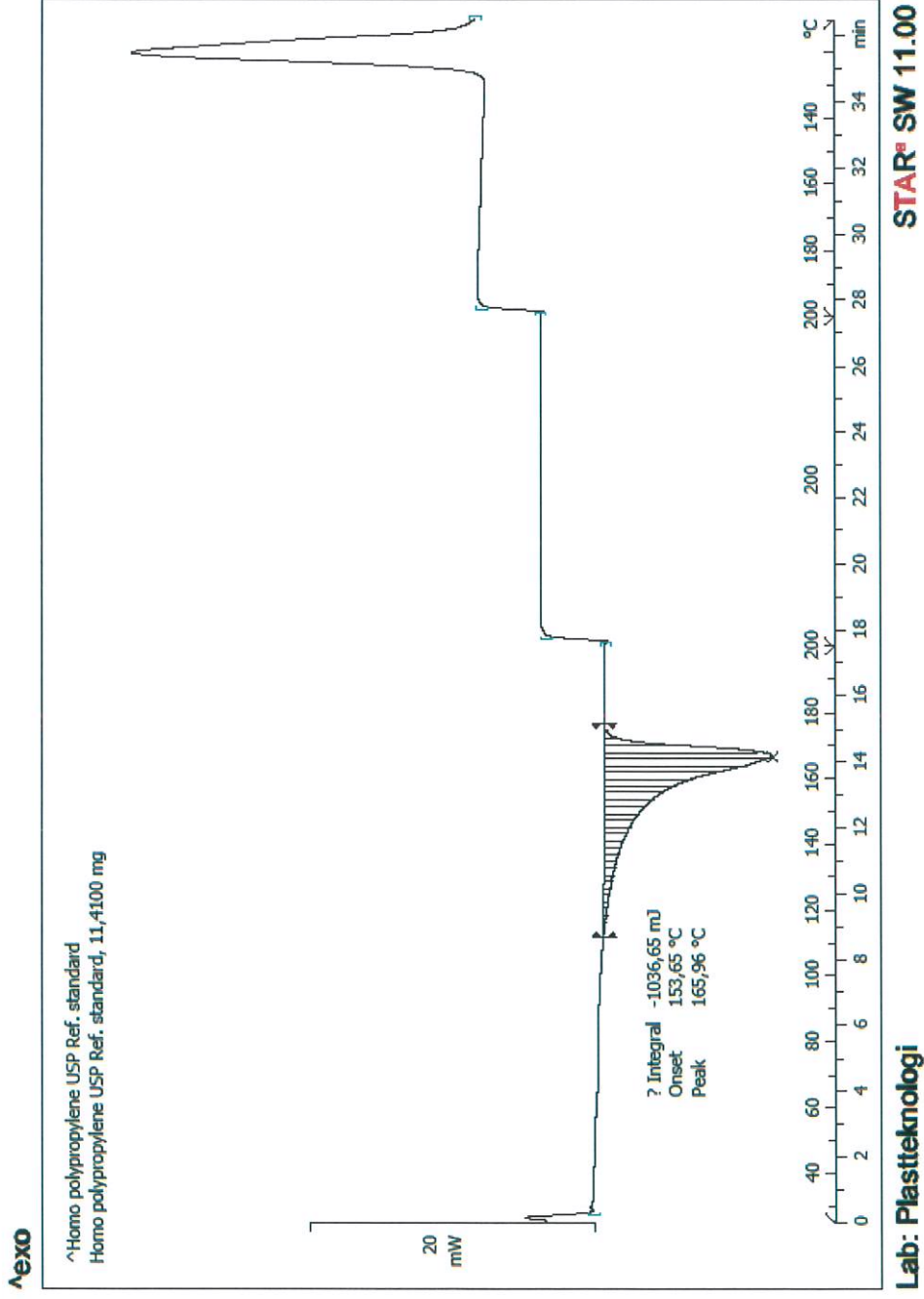

Ref sample of polypropylene

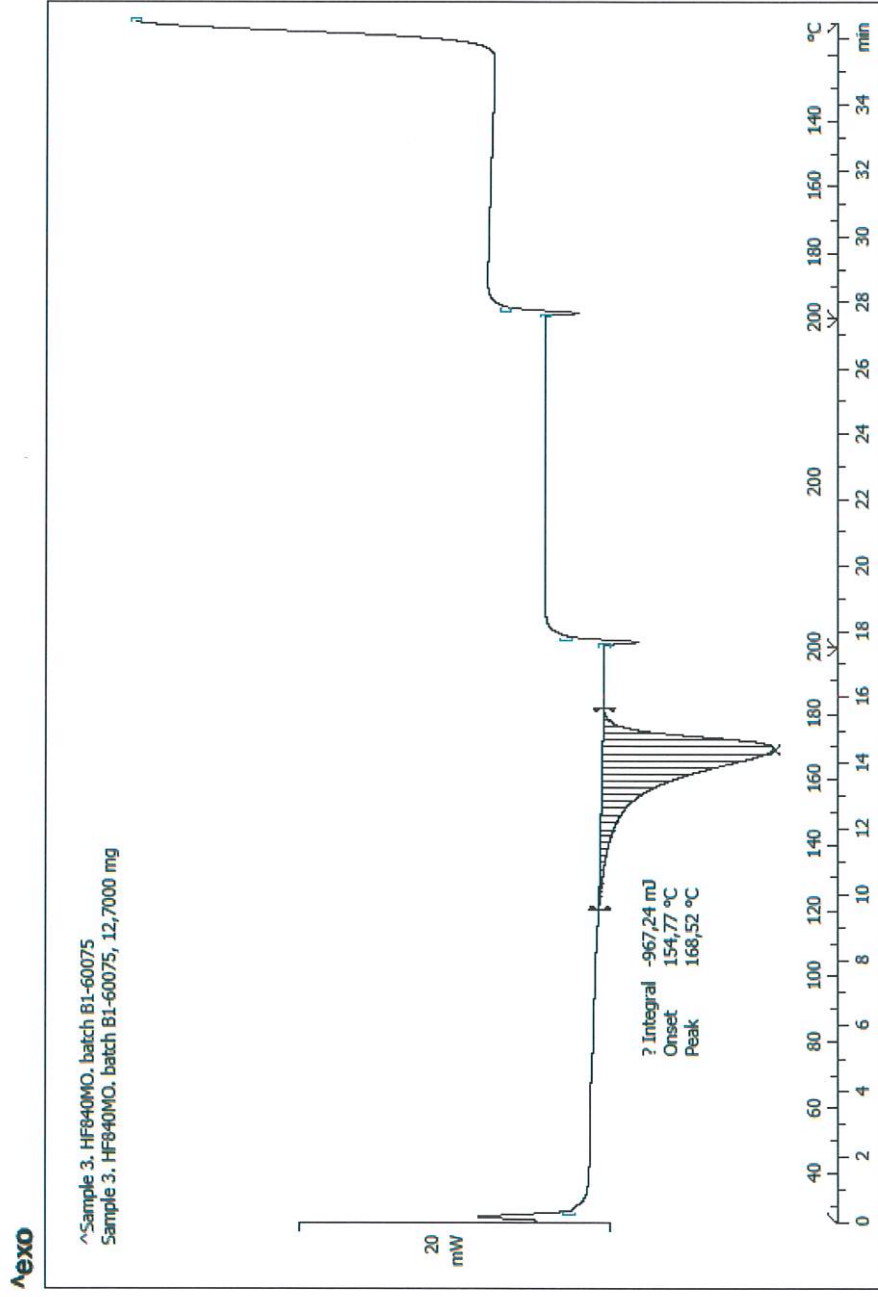

STAR® SW 11.00

Lab: Plastteknologi

DSC sample no. 3
Raw material: HF840MO (PP)
Batch no.: B1-60075

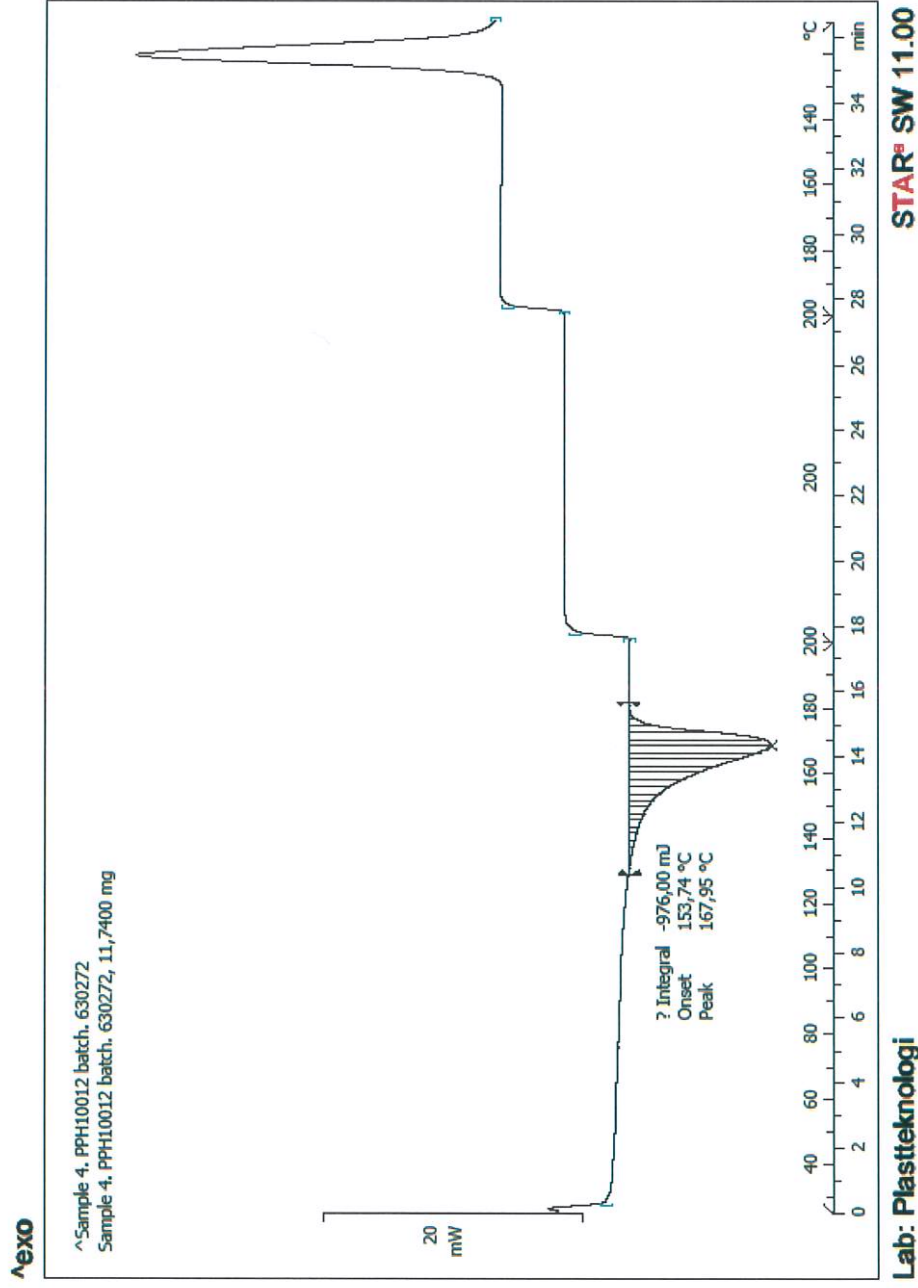

DSC sample no. 4
Raw material: PPH 10012 (PP)
Batch no.: 630272

AMENDED TEST RESULT REPORT

TE202033AR/ 20-B9818

Material: Pocket (30 mL) + Pocket Base

Lot: PPC 10712 + PPH 10012

**TESTS ON PLASTIC PACKAGING SYSTEMS FOR PHARMACEUTICAL USE -
USP 43 NF 38**

CHAPTER: 661.2

Client: Gerresheimer Vaerloese A/S

Contact: Mr. René Palmelund

Address: Walgerholm 2-8

3500 Vaerloese

Denmark

Client Purchase Order Number: 15191

Quotation Number: 2004165

Date Receipt Samples: 06 Jul 2020

Date Start Analysis: 23 Jul 2020

Date Technical Release: 30 Jul 2020

Date Final Test Result Report: 14 Aug 2020

Date Amended Test Report Result: 08 Sep 2020

REFERENCES:

United States Pharmacopoeia 43 NF 38, Chapter 661.2 section "Physicochemical Tests".



Iris Persy
Study Director



Stijn Nulens, Ing.
Quality Assurance Unit

RESULTS:

The results are presented in Table 1.

Table 1: Results of Analysis

Test	Results	Evaluation Criteria	Meets Criteria
Appearance of Solution C1	Clear, no color	Solution C1 is clear and colorless	PASS
Absorbance	≤ 0.20 A.u.	Maximum Absorbance between 230 nm to 360 nm ≤ 0.20 A.u.	Meets Specification
Acidity	+ 0.4 mL 0.01N NaOH → colorless to pink	≤ 0.4 mL of 0.01N NaOH → colorless to pink	PASS
Alkalinity	+ 0.8 mL 0.01 N HCl → pink to orange-red	≤ 0.8 mL of 0.01N HCl → pink to orange-red	PASS
TOC	≤ 8 mg/L	Maximum difference between sample and blank TOC ≤ 8 mg/L	Meets Specification

AMENDMENT

On customers request the following Amendment was made:

Lot: PHH 10012 was adjusted to PPH 10012

The applied Amendment has no impact on the integrity of the results and conclusion.

CONCLUSION:

Based on the evaluation criteria mentioned above, the test material *complies with the limits* of the United States Pharmacopoeia 43 NF 38, Chapter 661.2 section “Physicochemical Tests”, *and meets the specifications* for “Absorbance” and “TOC”.

TEST RESULT REPORT: 16-B3701-N1

Project Number:	TE161161	Report Date:	01/07/2016
Sponsor:	Gerresheimer Vaerloese A/S		
Contact Person:	<i>René Palmelund</i>		
Address:	Walgerholm 2-8	Date Sample Arrival:	15/06/2016
City, State, Zip:	3500 Vaerloese	Technical Initiation:	27/06/2016
Country:	Denmark	Technical Completion:	30/06/2016

Study:	Qualitative MEM-elution: Dye exclusion	Temp/Time	37°C/24 hours
Test article name:	03016A-0000	Ratio	4g/20mL
Lot number:	Sample 8	Vehicle	MEM-Complete

REFERENCE: According to "ISO 10993-5, 2009: Biological Evaluation of Medical Devices- Part 5: Tests for In Vitro Cytotoxicity." and "USP 39-NF 34, 2016: <87> Biological reactivity test, in vitro." Toxikon Reference: SOP 3.1.2.3, rev. 10

PROCEDURE: The biological reactivity of a mammalian monolayer, L929 mouse fibroblast cell culture, in response to the test item extract was determined. The sample and control articles were autoclaved prior to the preparation of the extracts. Extracts were prepared at 37±1°C for 24±2 hours in a humidified atmosphere containing 5±1% carbon dioxide (static). Positive (natural rubber) and negative (silicone) control articles were prepared to verify the proper functioning of the test system. The maintenance medium on the cell cultures is replaced by the extracts of the test item or control article in triplicate and the cultures are subsequently incubated for 2 days, at 37±1°C, in a humidified atmosphere containing 5±1% carbon dioxide. Biological reactivity was rated on the following scale: Grade 0 (No reactivity); Grade 1 (Slight reactivity), Grade 2 (Mild reactivity), Grade 3 (Moderate reactivity) and Grade 4 (Severe reactivity). The test item is considered to have no cytotoxic potential if none of the cultures exposed to the test item shows greater than mild reactivity (Grade 2).

RESULTS: No reactivity (Grade 0) was exhibited by the cell cultures exposed to the test item at the 2 days observation. Severe reactivity (Grade 4) was observed for the positive control article. The negative control article showed no signs of reactivity (Grade 0).

OPINION AND INTERPRETATION: Based on the evaluation criteria mentioned above, the test item is considered to have no cytotoxic potential.

RECORD STORAGE: All raw data generated in this study will be archived at Toxikon Europe, according to SOP 4.2.8.

AUTHORIZED PERSONNEL

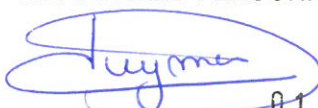
01 JUL 2016
Ms. Vanessa Ruymen
Study Director

04 JUL 2016
Ms. Anja De Schouwer
Quality Assurance

The test results on the enclosed report are only referring to the tested articles. Partly reproduction of this report can only be allowed after written permission of Toxikon. Toxikon guarantees that all results are acquired by testing according to officially accepted scientific methodology.

Quality Control

The quality assurance system of Primary Packaging Plastics is oriented towards a “zero defect strategy”. AQL values for dimensions must be within agreed specified limits. The necessary safety with respect to avoidance of dimensions out of specification (OOS) is achieved by means of process validation including risk analysis and/or in-line measurements and/or measurements on samples.

AQL values are defined on attributive characteristics according to below classification.

Classification of defects

Classification of defect	Effects of defects	Defect class	AQL		Consequence
			Containers / Caps		
Critical	<p>Critical defects are defects whose presence can have critical consequences. They can, for example:</p> <ul style="list-style-type: none"> • endanger human life or health • or violate legal requirements • or lead to destruction or alteration of filling material • or seriously impair the reliability of storage • or seriously impair the efficiency of production tools, filling and packaging equipment 	1	(*)	(*)	Packaging material not usable
Major	<p>Major defects are defects whose presence can lead to considerable impairment. They can, for example:</p> <ul style="list-style-type: none"> • lead to inefficient function and thus to deficiency of the packaging material/pack • or lead to consumer complaint • or lead to reduced efficiency in production • or impair the efficiency of production tools, and filling and packaging equipment 	2A	0.25	0.1	Usability of packaging material markedly impaired
		2B	1.0	0.4	Usability of packaging material moderately impaired
Minor	<p>Minor defects are defects whose presence do not have essential consequences, for instance they</p> <ul style="list-style-type: none"> • represent a reduction in general quality 	3	4.0	2.5	Usability of packaging material slightly impaired

(*) No AQL value is defined for defect class 1 since for this defect class, tests are done against zero defects with the greatest possible certainty and/or manufacturing process is to be correspondingly validated. The necessary safety with respect to the avoidance of critical defects class 1 is achieved by means of process validation measures including risk analysis and/or in-line inspection and system checks. If defects of class 1 are found, it must be determined whether the entire batch or part of the batch is affected.

If a partial quantity containing a critical, major or minor defect can be clearly and reliably separated, the quality of the remainder of the batch must be evaluated separately.

AQL values for Duma Pocket

Defects	Defect class
<ul style="list-style-type: none">- Raw material, primary packaging material or labelling not according to specification- Mix-up- CFU exceeds specification- Shelf life exceeded- Moisture vapour transmission or light transmission or single internal reflectance or physicochemical OOS according to USP (white products only)- Migration testing exceeds requirements for food contact material (white products only)- Contamination inside, contamination outside - can get into content- Tears, clefts, holes, parts incompletely moulded - usability or tightness not ensured- Defects on sealing points - tightness impaired- Engraved/embossed text is missing or incorrect- Threads from injection point - can be detached- 2 tags placed beside each other or more than 2 tags disconnected	1
<ul style="list-style-type: none">- Foreign bodies incorporated in the material- Contamination outside on product - cannot get into product- Inhomogeneous colour- Deformation, parts incompletely moulded - usability markedly impaired- Defects on sealing points - tightness not impaired- Injection point too high- Flashes - usability markedly impaired- Uneven surface- Burn marks > 2 mm- PE - Bags with holes or incorrectly closed	2A
<ul style="list-style-type: none">- Burn marks ≤ 2 mm- Notches and clefts and roughness- Flashes - usability moderately impaired- Threads from injection point - cannot be detached- 2 tags not placed beside each other disconnected	2B
<ul style="list-style-type: none">- 1 tag disconnected	3

If a carton is damaged or soiled upon arrival, the error must be noted at arrival on the shipping documents and the carton discarded. The remaining part of the batch is to be received as normal goods.

Quality control for Duma Pocket

Activity	Control
Incoming control of raw materials	Identification of goods received and control of certificates.
Set-up new mould or change of raw materials or control specification	Line clearance including control of correct use of raw materials. One sample of each cavity produced at the same time is visually controlled by production and QC prior to production start.
Production	<p>QC operator performs a visual control of the products in accordance with ISO 2859-1. The samples are taken every second hour (one sample per cavity produced at the same time).</p> <p>New approval by production and QC is required after machine stops lasting more than one hour.</p> <p>In case of unplanned machine stops where products can be defected the products are 100% controlled or scrapped.</p> <p>If defects are detected, products are quarantine stored or 100% controlled.</p>
Quality control	<p>QC reviews all the production documentation and point out products that need additional control. This also includes follow-up on products which are quarantine stored by production.</p> <p>QC performs a function test on samples from two of the in-process controls by mounting, open and re-closing the system. The samples are from two different shifts.</p> <p>QC controls the pallets for mix-up and incorrect labeling, releases the products and issue certificates with the results of the controls.</p>

Declaration of Conformity

European Pharmacopoeia (EP)

Declaration concerns all products with the following composition:

- **PPH 10012 / PPC 10712 & White**
- **PPC 10712 & White**

Based upon certificates from our suppliers of resins and masterbatches, Gerresheimer Vaerloese A/S hereby confirms that the above mentioned raw materials used during production comply with the relevant regulations related to plastic materials intended to come into contact with food however the suppliers do not declare the materials to be in compliance with the European Pharmacopoeia.

Yours sincerely,



Marta Slocka-Momotiuk
Compliance Specialist

Primary Packaging Plastics

DECLARATION OF CONFORMITY

**Gerresheimer Vaerloese A/S
Walgerholm 2-8
3500 Værløse, Denmark**

European Union (EU) Food Contact

Based upon the certificates from our suppliers of resins and masterbatch, product tests and our certified Quality system, Gerresheimer Vaerloese A/S hereby confirms that the below listed products comply with relevant requirements of Regulation (EC) No 1935/2004 (Framework Regulation) on materials and articles intended to come into contact with food, Regulation (EC) No 2023/2006 on good manufacturing practice for materials and articles intended to come into contact with food and Regulation (EU) No 10/2011 on plastic materials and articles intended to come into contact with food as amended inclusive Regulation (EU) 2019/1338.

- **Duma Pocket – White coloured products**
- **Duma Pocket Base – White coloured products**

The intended use for the above listed products is storage of medicine and foodstuff as powder and tablets without fatty surface according to the product specification. Shelf life is 5 years.

The products have been tested for contact with dry food to long time storing at room temperature.

A functional barrier made from plastic is not used in the above mentioned products.

When used as specified, tests have shown that overall and specific migration does not exceed the legal limits.

The formulation of the raw materials used for the production of the concerned products contains the below listed substances considered to be a dual-use substance according to Regulation (EU) No 10/2011:

- Calcium stearate
- Glycerin E422
- Ref no. 30610 Sodium, potassium and calcium salts of fatty acids E470a
- Glyceryl monostearate E471
- Ref no. 56585 Mono-and diglycerides of fatty acids E471
- Ref no. 30960 Polyglycerol esters of fatty acids E475
- Ref no. 92080 Talc E553b
- Stearic acid E570

The product contain components with specific migration limits:

- | | | |
|----------------------|---|--------------------|
| • Cas no. 7429-50-5 | Aluminium | SML = 1 mg/kg |
| • Cas no. 7439-93-2 | Lithium | SML = 0.6 mg/kg |
| • Ref no. 39815 | | |
| | 9,9-Bis(methoxymethyl)fluorene | SML = 0.05 mg/kg |
| • Ref no. 46880 | | |
| | 3,5-di-tert-butyl-4-hydroxybenzylphosphonic acid | SML = 6 mg/kg |
| • Ref no. 55910 | | |
| | Glycerides, castor- oil mono-, hydrogenated, acetates | SML(T) = 60 mg/kg |
| • FCM no. 141 | | |
| | 1,1,1-Trimethylolpropane | SML = 6 mg/kg |
| • Cas no. 85209-93-4 | | |
| | 12H-Dibenzo(d,g)(1,3,2)dioxaphosphocin | SML = 5 mg/kg |
| • Cas no 182121-12-6 | | |
| | 9,9-bis(methoxymethyl)flourine | SML = 0.05 mg/kg |
| • Cas no 70955-14-5 | | |
| | N,N-Bis(2-hydroxyethyl)alkyl(C13-C15)amine | SML(T) = 1.2 mg/kg |

The migration tests have been performed according to Regulation (EU) No. 10/2011 (Annex V):

- Test conditions (contact time above 30 days at room temperature):

Overall migration:	Tenax	10 days / 60°C
Specific migration:	10% ethanol	10 days / 60°C
Annex II elements:	10% ethanol	10 days / 60°C
- Surface to volume ratio: 0,73 dm² / 120 ml

Sensory analysis showed a weak deviation of the odour / flavour.

USA Food and Drug Administration and US Pharmacopoeia (USP)

Based upon certificates from our suppliers of resins and masterbatch, we state compliance of Polypropylene PPC 10712 & Polypropylene PPH 10012 with relevant parts of FDA title 21 CFR § 177.1520 and of 20-2060-PW-6 with relevant parts of FDA title 21 CFR §§ 177.1520 & 178.3297.

The products comply with the requirements defined in the USP in relation to the following tests:

- <661> Single Internal Reflectance
- <661> Physicochemical test
- <671> Moisture Vapour Transmission
- <671> Light Transmission

Værløse, May 21, 2021



Christina D. Holder
Quality Manager

April 27, 2021

Declaration of Conformity

Primary Packaging Plastics requires from all raw materials suppliers to inform about any animal derived substances used for production of their products and also requests from suppliers to consider and fulfill the relevant regulations of the European Community about the avoidance of TSE/BSE contamination.

If applicable, all suppliers are requested to fulfil the requirements:

- The animal derived substances used for the manufacturing of their polymers are either produced from animals originating from BSE-free countries or are free from SRM (specified Risk Material).
- The manufacture of the animal derived substances involves rigorous processes that meet/exceed the very severe process conditions for inactivating any BSE/TSE agent.

If any of raw materials contain ancillary materials based on fatty acid, such fatty acids might have a number of origins from for example plants, animal or synthetic, where the animal origin is the most common. The use of these subsidiaries as ancillary materials, including packaging for the pharmaceutical-and the foodstuff industries, are regulated through a number of EU directives. Tallow derived materials used in some product fulfill the requirements laid down in the Regulations 1069/2009/EC, and 142/2011/EC, and the "Note for Guidance EMEA/410/01, rev. 3". These directives regulate the general use of these products and specifically security against BSE to transmit to pharmaceutical-or foodstuff products.

Primary Packaging Plastics has received statements or certificates from all suppliers, where they state that:

- their products do not contain specific material of risk (SRM) and that infection does not transmit via their products, or
- their products fulfilled all requirements laid down in relevant regulations concerning BSE/TSE substances.

Yours sincerely,



Marta Słocka-Momotiuk
Compliance Specialist
Primary Packaging Plastics

April 14, 2020

Declaration of Conformity

Primary Packaging Plastics only process raw materials delivered from suppliers and does not add any additional materials to such raw materials. Based upon certificates from raw materials suppliers, Primary Packaging Plastics hereby confirms that:

- Allergens
- Latex
- Melamine
- Bisphenol A
- Phthalates

have not been intentionally added during their production. However, the fact that these substances are not used in these products does not exclude that trace levels of them may be present as a result of the specific characteristics of raw materials and/or of the manufacturing process. Please note that, in any case suppliers do not carry out any specific analyses in order to detect the presence of above mentioned substances.

The information is given to the best of our knowledge and does not include any warranty whatsoever. It must therefore not be misunderstood as guaranteeing specific properties. End-customers have to decide at their own discretion about the suitability of our products for their purposes, based on the explicit descriptions in our product specifications.

Yours sincerely,



Katarzyna Jawor
Compliance Specialist
Primary Packaging Plastics

DECLARATION OF CONFORMITY

**Gerresheimer Vaerloese A/S
Walgerholm 2-8
3500 Værløse, Denmark**

Gerresheimer Vaerloese A/S has taken appropriate precautions to reduce the risk for TBA (2,4,6-tribromoanisole) and TCA (2,4,6-trichloroanisole) contamination of products supplied to our customers.

TBA with a threshold of 0.02 PPT and TCA with a threshold of 1 PPT do not introduce any toxicological risks but can have impact in musty molded odor.

Risk for TBA/TCA contamination is included into the risk analysis for the whole manufacturing and handling/storage process in the plant and all wooden pallets used for raw materials, component and final products are heat treated and comply with ISPM 15.

Gerresheimer Vaerloese A/S can only be held responsible for any odor issues due to TBA and/or TCA contamination, if it can be proven that the contamination of the primary plastic packaging has happened before shipment of the products.

Værløse, April 16th, 2020



Christina D. Holder
Quality Manager

Customer Complaint Report

<input type="checkbox"/> Complaint <input type="checkbox"/> Comment / Remark Customer report No:	Established by / date:
Customer name / address / country:	Contact person / E-mail / Fax no.:
Article no.:	Date of delivery:
Batch no.:	Invoice no.:
Cavity no.:	Order no.:
Number of defective items:	Total quantity delivered:
Defect observed in: <input type="checkbox"/> Incoming control..... Sample size: <input type="checkbox"/> Production..... Quantity of items used: <input type="checkbox"/> Final product(s)..... Quantity of items used: <input type="checkbox"/> Complaint from end-user	
Defect found in: <input type="checkbox"/> One carton <input type="checkbox"/> Several cartons: Quantity _____	Exact production date/time from carton/bag or carton/bag/pallet number: <input type="checkbox"/> Not available
Are filled/not filled products quarantined: <input type="checkbox"/> Yes – Quantity (filled): <input type="checkbox"/> Yes – Quantity (not filled): <input type="checkbox"/> No <input type="checkbox"/> N/A – no products left	Samples: <input type="checkbox"/> Will be sent <input type="checkbox"/> Not available <input type="checkbox"/> Additional information will be forwarded
Description of defect:	

Received by QA dept. (init. / date): _____

Information requested in relation to complaint investigation

We will kindly ask you to supply us with the answers to the below listed questions. The information is important for us, to make a thorough investigation.

Please return the information as soon as possible, so that we can initiate our investigation.

Labelling

Company name:	Today's date:
<input type="checkbox"/> Wrong information <input type="checkbox"/> Missing information <input type="checkbox"/> Missing label <input type="checkbox"/> Label difficult to read	
<input type="checkbox"/> Samples have been send <input type="checkbox"/> Samples will be send <input type="checkbox"/> Pictures are available <input type="checkbox"/> No samples or pictures are available	
The defect is observed in <input type="checkbox"/> One bag/carton <input type="checkbox"/> Several bags/cartons - Quantity	
Exact production date and time for all concerned bags	
Exact quantity of defective items/bags/cartons	
How many bags/cartons have been controlled	
Amount of products blocked	
Comments:	

Information requested in relation to complaint investigation

We will kindly ask you to supply us with the answers to the below listed questions. The information is important for us, to make a thorough investigation.

Please return the information as soon as possible, so that we can initiate our investigation.

Loose silica gel / loose desiccant / defect on desiccant

Company name:	Today's date:
<input type="checkbox"/> Samples have been send <input type="checkbox"/> Samples will be send <input type="checkbox"/> Pictures are available <input type="checkbox"/> No samples or pictures are available	
Defect observed in: <input type="checkbox"/> Upon reception at your warehouse <input type="checkbox"/> Incoming inspection - sample size/plan: _____ <input type="checkbox"/> Observed in PDS <input type="checkbox"/> Before filling/when opening the cartons <input type="checkbox"/> Before filling/on your line <input type="checkbox"/> After filling <input type="checkbox"/> Market complaint	
Defect observed in <input type="checkbox"/> One bag <input type="checkbox"/> Several bags - Quantity	
Exact production date and time for all concerned bags	
Exact quantity of defective items	
Are there any signs of damage to cap, desiccant or cardboard	
Are there any signs of transport damage to bag or carton	
Quantity of item used or controlled from the batch	
Amount of products blocked	
Amount of filled products blocked	
Comments:	

Information requested in relation to complaint investigation

We will kindly ask you to supply us with the answers to the below listed questions. The information is important for us, to make a thorough investigation.

Please return the information as soon as possible, so that we can initiate our investigation.

Mix-up

Company name:	Today's date:
Ordered product	
Product received	
How many bags/cartons have been controlled	
Amount of products blocked	
Production date and time of all the concerned bags/cartons	
<input type="checkbox"/> Samples have been send <input type="checkbox"/> Samples will be send <input type="checkbox"/> Pictures are available <input type="checkbox"/> No samples or pictures are available For for mix-up - both carton label and bag label is important – and it would be helpful, if the pictures also showed the production date/time.	
Comments:	

Information requested in relation to complaint investigation

We will kindly ask you to supply us with the answers to the below listed questions. The information is important for us, to make a thorough investigation.

Please return the information as soon as possible, so that we can initiate our investigation.

Partly- or disconnected TE-rings

Company name:	Today's date:
<input type="checkbox"/> Samples have been send <input type="checkbox"/> Samples will be send <input type="checkbox"/> Pictures are available <input type="checkbox"/> No samples or pictures are available	
Quantity of caps with disconnected TE-rings	
Quantity of caps with partly disconnected TE-rings <i>Please specify quantity of broken bridges according to the AQL values/specification.</i>	
Specific cavity number affected	
Defect observed in: <input type="checkbox"/> Incoming inspection - sample size/plan: _____ <input type="checkbox"/> Observed in PDS <input type="checkbox"/> Before filling/when opening the cartons <input type="checkbox"/> Before filling/on your line <input type="checkbox"/> After filling <input type="checkbox"/> Market complaint	
Quantity of item used or controlled from the batch	
Amount of products blocked	
Amount of filled products blocked	
Defect observed in <input type="checkbox"/> One bag/carton <input type="checkbox"/> Several bags/cartons - Quantity	
Exact production date and time for all concerned bags	
Are there signs of damage to the cap/bag/carton	
Comments:	

Information requested in relation to complaint investigation

We will kindly ask you to supply us with the answers to the below listed questions. The information is important for us, to make a thorough investigation.

Please return the information as soon as possible, so that we can initiate our investigation.

Product defect

Company name:	Today's date:
<input type="checkbox"/> Samples have been send <input type="checkbox"/> Samples will be send <input type="checkbox"/> Pictures are available <input type="checkbox"/> No samples or pictures are available	
Defect observed in: <input type="checkbox"/> Upon reception at your warehouse <input type="checkbox"/> Incoming inspection - sample size/plan: _____ <input type="checkbox"/> Observed in PDS <input type="checkbox"/> Before filling/when opening the cartons <input type="checkbox"/> Before filling/on your line <input type="checkbox"/> After filling <input type="checkbox"/> Market complaint	
Exact quantity of defective items	
Specific cavity number affected	
Quantity of item used or controlled from the batch	
Amount of products blocked	
Amount of filled products blocked	
Defect observed in <input type="checkbox"/> One bag <input type="checkbox"/> Several bags – Quantity	
Exact production date and time for all concerned bags	
Comments:	

Information requested in relation to complaint investigation

We will kindly ask you to supply us with the answers to the below listed questions. The information is important for us, to make a thorough investigation.

Please return the information as soon as possible, so that we can initiate our investigation.

Transport

Company name:	Today's date:
<input type="checkbox"/> Pictures are available <input type="checkbox"/> No pictures are available	
<input type="checkbox"/> A copy of the CMR ("Proof of delivery" from the transporter) has been forwarded <input type="checkbox"/> A copy of the CMR ("Proof of delivery" from the transporter) will be forwarded <input type="checkbox"/> The CMR ("Proof of delivery" from the transporter) is not available	
Defect observed on <input type="checkbox"/> One carton <input type="checkbox"/> Several cartons	
Exact quantity of damaged cartons	
Products can be used	<input type="checkbox"/> yes / <input type="checkbox"/> No
Comments: 	