

PRICELIST

STANDARDSORTIMENT

General terms and conditions of sale and delivery

Freight costs: Freight costs follow current rates of used forwarding agent

Cliché costs EUR 115 / pcs.

Invoice fee When purchasing goods for less than EUR 135 an invoice fee of EUR 12,75 will be added.

Nostalgia – Series 9000

Stylish and elegant box



Nostalgia jewellery box

Smart lift-off box. The box can be used in displays.

- Good packaging for inexpensive jewellery
- Choose between cotton wool* or flocked foam inserts
- Available in the colours: black, blue
- Imprint: company name and logo can be imprinted on the lid.

Nostalgia series 9000

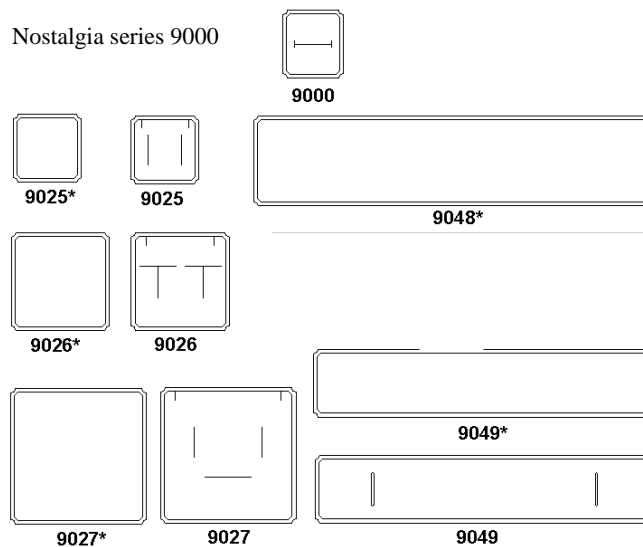

Item no.:	Description:
9000	Ring
9025/*	Jewellery box I, with foam or cotton*
9026/*	Jewellery box II, with foam or cotton*
9027/*	Jewellery box III, with foam or cotton*
9048/*	Jewellery box, with cotton
9049/*	Jewellery box for bracelet/ watch With foam or cotton*

Size (mm):
40 x 46 x 34
40 x 40 x 20
60 x 60 x 22
85 x 85 x 25
260 x 55 x 25
220 x 40 x 25

Jarnes A/S**Nostalgia
Series 9000**

January 2011

Price in EUR

Description	Size/mm	Qty. pr. outer case	Item no.	1000	100
Jewellery box I – cotton wool	40x40x20	100	9025*	0,23	0,25
Jewellery box II – cotton wool	60x60x22	100	9026*	0,30	0,33
Jewellery box III – cotton wool	85x85x25	100	9027*	0,44	0,48
Jewellery box – cotton wool ** blue or black	260x55x25	50	** 9048*	0,86	1,03
Jewellery box – cotton wool	220x40x25	50	9049*	0,67	0,81
Ring	40x46x34	100	9000	0,29	0,32
Jewellery box I – foam	40x40x20	100	9025	0,24	0,27
Jewellery box II – foam	60x60x22	100	9026	0,31	0,34
Jewellery box III – foam	85x85x25	100	9027	0,48	0,51
Bracelet/Watch	220x40x25	50	9049	1,22	1,33

**** In stock in blue and black**

Print:	Golden tampon print, on the lid	Colour	Outside	Interior	Cotton wool colour
Insert:	9049 – plain lining	1	Black	Black	Grey
		2	Blue	Blue	Yellow
		11 (***)	Pink		White
Price:	Incl. 1 tampon print - without print – 5 % discount Extra charge for hot stamping print: €0,03/pcs	40	Grey	Grey	Grey

EDB: 9025-1* Black Jewellery box with cotton.

Nostalgia Transparent – Series 9000 Red

Red eye-catcher



Stackable jewellery box

Transparent lift – off box.

The boxes can be used in displays as it is stackable.

A good packaging solution for inexpensive jewellery.

- Insert: choose between white cotton wool and white flocked foam.
- Available colours: transparent red.
- Imprint: golden or silver, placed on the lid.

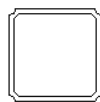

9025*

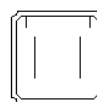

9025

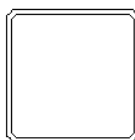

9026*

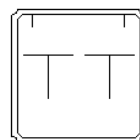

9026

Item no.:	Description:	Size (mm):
9025*	Jewellery box I – with cotton*	40 x 40 x 20
9026*	Jewellery box II – with cotton*	60 x 60 x 22
9025	Jewellery box I – with foam	40 x 40 x 20
9026	Jewellery box II – with foam	60 x 60 x 22

Jarnes A/S**Nostalgia Transparent
Series 9000 Red**

January 2011

Price in EUR

Item	Size /mm	Qty. pr. outer case	Item no.	1000	100
------	----------	---------------------------	----------	------	-----

Jewellery box I – cotton	40x40x20	100	9025*	0,23	0,25
Jewellery box II – cotton	60x60x22	100	9026*	0,30	0,33
Jewellery box I – foam	40x40x20	100	9025	0,24	0,27
Jewellery box II – foam	60x60x22	100	9026	0,31	0,34

Imprint:	Golden or silver, placed on the lid	Colour	Outside	Foam	Cotton
Insert:	Foam or cotton wool	52	Red	White	White

EDB: 9025-52x Transparent red jewellery box with white cotton.

Series 200

Popular series for all types of jewellery



Attractive, functional and inexpensive series

- Inexpensive series for all types of jewellery
- Grain leather surface
- Hinged box with gold-rimmed lid
- Available in: black and blue
- Imprint: company name and logo can be imprinted on the lid.

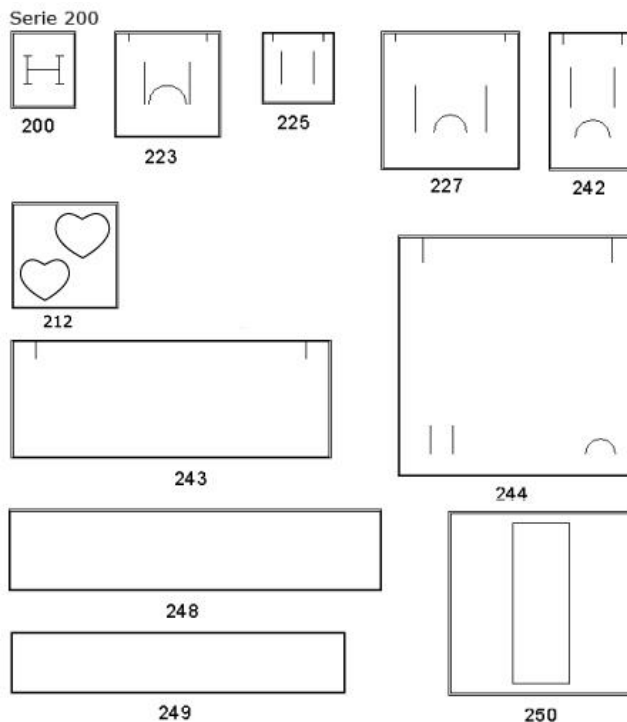

Item no.:	Description:	Size (mm):
200	Ring	40 x 48 x 33
212	Wedding rings, vacuumed insert in heart shape	67 x 67 x 21
223	Universal, earrings or pendant w. chain	67 x 67 x 21
225	Universal small, earrings	45 x 45 x 21
227	Universal large	88 x 88 x 21
242	Chain w. pendant	55 x 88 x 21
243	Collier for pearls	206 x 75 x 21
244	Collier, large	154 x 155 x 23
248	Bracelet/ watch	241 x 51 x 21
249	Bracelet/ watch	216 x 38 x 21
250	Watch	88 x 88 x 47

Jarnes A/S**Series 200**

January 2011

Price in EUR

Item	Size /mm	Qty. pr. outer case	Item nr.			300	100
Ring	40x48x33	100	200			0,30	0,45
Wedding rings (heart form insert)	67x67x21	20	212			1,17	1,35
Earrings	45x45x21	100	225			0,37	0,57
Universal	67x67x21	100	223			0,41	0,69
Universal	88x88x21	100	227			0,58	1,02
Universal	55x88x21	100	242			0,41	0,84
				1000	500	100	50
Collier	206x75x21	25	243			1,25	1,96
Bracelet/ watch ** blue or black	241x51x21	50	** 248	1,35	1,40	1,56	1,73
Bracelet/ watch	216x38x21	25	249			0,88	1,27
Bracelet w. ring/ vacuumed insert Available in black only	88x88x47	50	247	1,20	1,24	1,37	1,54
Bracelet/ watch Available in black only	88x88x47	50	250	1,22	1,23	1,35	1,52
						100	20
Collier	154x155x23	20	244			1,97	3,26

**** In blue and black.**

Imprint:	Gold tampon print on lid; Gold – rimmed on lid	Colour code	Outside	Colour of the foam	Colour of the cotton
Insert:	Mark*indicates for cotton wool insert. 212 and 250 has vacuumed insert – other boxes are with foam insert	1	Black	Black	Grey
		2	Blue	Blue	Yellow
Price:	Incl. 1 tampon print – without print – 5 % discount Extra charge for hot stamping: € 0, 03/ pcs.				

EDB: 200-1 Black ring box with foam inserts.

Soft Octagon Uno – Series 2100

Classic box in a clean style



Good quality packaging solution with foam inserts

- Box with small push-button closing
- Available in black and dark grey
- Mat surface ideal for imprinting
- Imprint: company name and logo can be printed on the lid.

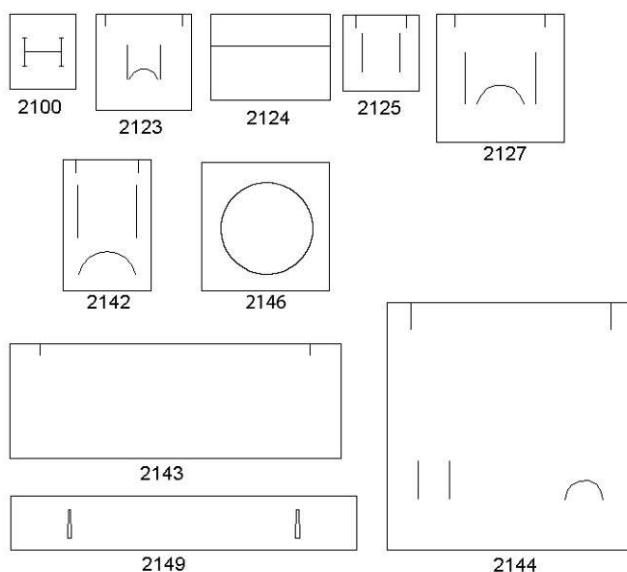

Item no.:	Description:	Size (mm):
2100	Ring	41 x 47 x 31
2125	Small universal, earrings	48 x 48 x 18
2123	Medium universal, earrings/collier w. pendant	60 x 60 x 20
2127	Large universal, earrings/ collier w. pendant	80 x 80 x 20
2146	Bracelet w. vacuumed insert	80 x 80 x 20
2142	Collier w. pendant	55 x 82 x 20
2143	Collier for pearls, large	207 x 72 x 18
2149	Bracelet/ watch	216 x 34 x 18
2144	Collier, large	155 x 155 x 20
2124	Wedding rings	75 x 54 x 24

Jarnes A/S**Soft Octogon – UNO
Series 2100**

January 2011

Price in EUR

Item	Size/ mm	Qty. pr. outer case	Item no.	1000	500	100
Ring	41x47x31	100	2100	0,43	0,45	0,48
Universal II	60x60x20	100	2123	0,60	0,64	0,67
Universal I	48x48x18	100	2125	0,50	0,53	0,54
Universal III	80x80x20	100	2127	0,71	0,75	0,79
Collier w. pendant	55x82x20	100	2142	0,71	0,75	0,79
				500	200	50
Collier	207x72x18	25	2143	1,67	1,77	1,86
Bracelet	216x34x18	25	2149	1,47	1,54	1,62
				500	200	20
Collier – large	155x155x20	20	2144	2,68	2,82	2,97

Insert:	Foam in the bottom and lid.	Colour	Outside	Interior
Print:	Golden or silver tampon print placed on the lid.	40	Grey	Grey
Price:	Incl. 1 print. Without print 5 % discount. Charge for hot stamping print € 0, 03/ pcs.	1-1	Black	Black

EDB: 2123-40 Universal, grey etui w. foam insert.

Jarnes A/S**Soft Octogon – UNO – LUX
Series 2100**

January 2011

Luxury insert and satin lid pad
Price in EUR

Item	Size/ mm	Qty. pr. outer case	Item no.	1000	500	100
Ring	41x47x31	100	2103	1,21	1,27	1,42
Wedding rings	75X54X24	100	2124	1,83	1,94	2,16
Collier w. pendant	60x60x20	100	2160	1,60	1,70	1,88
Bracelet, vacuumed insert	80x80x20	100	2146	1,83	1,94	2,16
				500	200	20
Collier – large	155x155x20	20	2144	5,45	5,79	6,81

Insert:	Luxurious insert in the bottom and satin lid pad.	Colour	Outside	Interior
Print:	Golden or silver, placed on the lid pad.	40-LUX	Grey	Grey
Price:	Incl. 1 print. Without print 5 % discount. Charge for hot stamping € 0, 03/ pcs.	1-LUX	Black	Black

EDB: 2146-40-LUX Grey box for bracelet.

Soft Octagon Juicy Series 2100

Young and fresh – a real eye catcher



Give your customers a juicy case...

Strong and functional case in all colours of the rainbow with a surface, which is ideal for imprinting. A small push-button closing device makes it easy to open. A really good, quality packaging solution.

- Hinged etui with matt surface;
- Sloping front and rear edges of box top;
- Flocked foam insert in top and bottom;
- Available in transparent: red, pink, orange, yellow and fresh green
- Imprint: company name and logo can be imprinted in golden, silver or black on the lid.

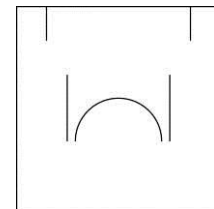

Insert

Item no.:
2123

Description:
Universal II

Size (mm):
60 x 60 x 20



Jarnes A/S**Soft Octogon Juicy
Series 2100**

January 2011

Price in EUR

Item	Size/ mm	Qty. pr. outer case	Item no.	500	300
Universal II	60x60x20	100	2123	0,64	0,67

Series:	Plastic box with small push-button closing. The top with sloping front and rear edges.	Colour	Outside	Inside
		50	Orange	White
		51	Lime	White
Insert:	Foam in the bottom and lid.	52	Red	White
Print:	Golden, silver or black placed on the lid.	53	Pink	White
Price:	Incl. 1 print	54	Yellow	White

EDB: 2123-50 Universal, orange box w. foam insert.

Soft Octagon – Series 2200

Classic box with golden edge



Good quality packaging solution

Sloping front and rear box-top edges with decorative gold rim, which lends a very elegant touch to the case.

A small push-button closing device makes it easy to open the case.

- Hinged case with mat surface
- Flocked foam inserts in top and bottom
- This line is available in black
- Surface is ideal for imprinting
- Imprint: company name and logo can be imprinted on outer surface of lid.

Item no.:	Description:	Size (mm):
2200	Ring	41 x 47 x 31
2225	Universal small for earrings	48 x 48 x 18
2223	Universal medium, for earrings, collier w. pendant	60 x 60 x 20
2227	Universal large, for earrings, collier w. pendant	80 x 80 x 20
2246	Bracelet w. vacuumed insert	80 x 80 x 20
2242	Collier w. pendant	55 x 82 x 20
2243	Collier for pearls, large	207 x 72 x 18
2249	Bracelet/ watch	216 x 34 x 18
2244	Collier large	155 x 155 x 20

Jarnes A/S**Soft Octagon
Series 2200**

January 2011

Price in EUR

Item	Size /mm	Qty. pr. outer case	Item no.	1000	500	100
Ring	41x47x31	100	2200	0,45	0,48	0,50
Universal II	60x60x20	100	2223	0,63	0,67	0,70
Universal I	48x48x18	100	2225	0,52	0,55	0,58
Universal III	80x80x20	100	2227	0,75	0,79	0,84
Collier w. pendant	55x82x20	100	2242	0,75	0,79	0,84
				1000	500	50
Collier	207x72x18	25	2243	1,76	1,86	1,96
Bracelet/ watch	216x34x18	25	2249	1,54	1,62	1,70
				500	200	20
Collier – large	155x155x20	20	2244	2,81	2,97	3,12

Insert:	Foam in lid and bottom	Colour	Outside	Interior
Print:	Golden tampon print on the lid. Golden edge on the lid.	1-1	Black	Black
Price:	Incl. 1 print. Without print 5 % discount. Extra charge for hot stamping € 0, 03/ pcs.			

EDB: 2223-1-1 Universal, black box with foam insert.

Jarnes A/S**Soft Octagon – LUX
Series 2200**

January 2011

Luxury insert and satin lid pad
Price in EUR

Item	Size/mm	Qty. pr. outer case	Item no.	1000	500	100
Ring	41x47x31	100	2203	1,33	1,41	1,57
Engagement rings	75X54X24	100	2224	2,02	2,14	2,38
Collier w. pendant	60x60x20	100	2260	1,76	1,87	2,07
Bracelet	80x80x20	100	2246	2,02	2,14	2,38
				500	200	20
Collier – large	155x155x20	20	2244	6,00	6,37	7,50

Insert:	Luxurious insert in bottom and satin lid pad	Colour	Outside	Interior
Imprint:	Golden tampon print on white or black lid pad. Golden edge on the lid.	1-LUX	Black	Black
Price:	Incl.1 logo print. Without print – 5 % discount. Extra charge for hot stamping print € 0, 03/ pcs.			

EDB: 2246-1-LUX Black box w. insert for bracelet.

Fancy Box – Series 2256

Decorated box with foam insert



Attractive, functional, and inexpensive cases

Inexpensive line with hinged lid

- Coloured base and a clear transparent lid
- The bottom comes with a flocked white or black foam inserts that makes it versatile
- At a minimum buy of 5000 pcs. pr. article number the line is available in Jarnes standard colours and the transparent colours of the Octogon Juicy line.
- When buying a minimum of 10,000 pcs pr. article number the box can be delivered in any desired colour.

Insert in: black or white:



2256-37

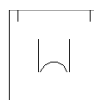

2256-38

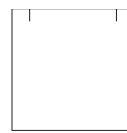

2256-39

Jarnes standard colours: black, blue, bordeaux, white and grey.

Octogon Juicy Line transparent colours: red, pink, yellow, orange and fresh green.

Item no.	Description	Size (mm)
2256-37	Chain w. pendant or earrings	48x48x18
2256-38	Chain w. pendant, earrings and ring	60x60x20
2256-39	Chain w. pendant	80x80x20

DISPLAY

Item no.	Description	Size (mm)
2256-37-9	Display for 9 pcs 2256-37 etuis	300x280x15
2256-38-9	Display for 9 pcs 2256-38 etuis	300x280x15
2256-39-6	Display for 6 pcs 2256-39 etuis	300x280x15

Jarnes A/S**Fancy Box
Series 2256**

January 2011

Price in EUR

Item	Size/ mm	Item no.	10.000	5.000	3.000
Chain w. pendant or earrings	48x48x18	2256-37	0,26	0,28	0,43
Chain w. pendant, earrings and ring	60x60x20	2256-38	0,33	0,36	0,54
Chain w. pendant	80x80x20	2256-39	0,48	0,52	0,67
Item					5pcs
Display for 2256-37 For 9 pcs etuis	300x280x15	2256-37-9			33,29
Display for 2256-38 For 9 pcs etuis	300x280x15	2256-38-9			33,29
Display for 2256-39 For 6 pcs etuis	300x280x15	2256-39-6			33,29

Series	Plastic etui w. transparent lid and coloured bottom.	Colour	Outside	Interior
Insert:	Foam insert, available in white and black.	50	Orange	White (6) or Black (1)
		51	Green	White (6) or Black (1)
Imprint:	Tampon print in the same colour as the bottom or by agreement.	52	Red	White (6) or Black (1)
		53	Pink	White (6) or Black (1)
Price:	Incl. 1 pcs tampon print.	54	Yellow	White (6) or Black (1)
		1	Black	White (6) or Black (1)

EDB: 2256-38-1-6 Black box for chain w. pendant, earrings and ring, with white insert.



Made in Denmark – Series 2900

- Danish quality - produced in Denmark



Made in Denmark is produced in Denmark, by Danish standards, in a good quality that we can vouch for. The box is coated with glossy black or white paper.



2904

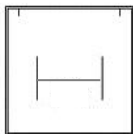

2928



2900

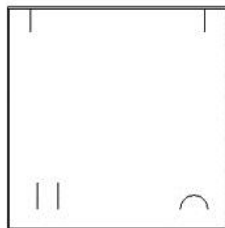

2944

- The bottom is fitted with a flocked foam insert with cuts.
- Logo: gold or silver print on the outside of the lid.

Item no: Description:

2900	Ring
2904	Earrings
2928	Ring, earrings, chain w/pendant
2928-h	Ring, earrings, chain w/pendant – extra height
2944	Collier
2944-h	Collier – extra height

Size: (mm)

45 x 45 x 29
45 x 45 x 18
78 x 78 x 25
78 x 78 x 55
155 x 155 x 28
155 x 155 x 60

Ket box – Series 2800

Smart and inexpensive solution



Ket is a smart functional cardboard series. Available in matt black and glossy black or glossy white.

- Flocked foam insert
- Imprint: golden or silver on the lid
- The series is not produced in Denmark, but purchased in China.



2804

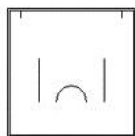

2827

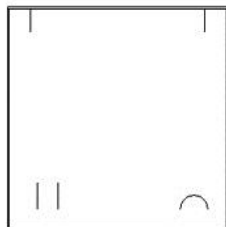

2844



2800

Item no:	Description:
2800	Ring
2804	Earrings
2828	Ring, earrings, collier w. pendant
2844	Collier

Size: (mm)
48 x 55 x 32
47 x 51 x 20
85 x 85 x 30
175 x 175 x 25

White Magic – Series 3100

Combination of matt and glossy paper, with magnet closing



White Magic

White Magic is a new line with a smart magnetic closure on the front. White Magic is coated with both matt and glossy white paper which gives them an exciting appearance

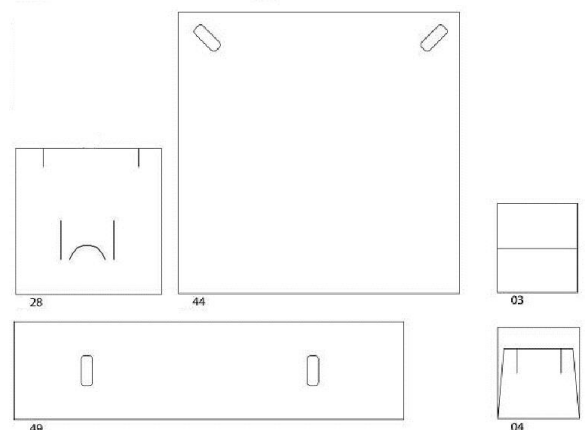

- Flocked foam inserts at the bottom with cuts.
- Imprint: company name and logo can be imprinted on the lid.
- The series is not produced in Denmark, but purchased in China.

Item no.:	Description:	Size (mm):
3103	Ring	45 x 45 x 30
3104	Earrings	48 x 44 x 23
3128	Ring, earrings, collier w. pendant	90 x 90 x 30
3144	Collier, large	155 x 150 x 29
3149	Bracelet	215 x 45 x 20

Soft Touch – Series 3200

Series of leatherette covered jewellery boxes



A confident choice

New black luxurious series of boxes with classic and timeless soft leather look surface.

- A confident choice of classic and stylish packaging solution;
- Hinged box, leatherette covered
- Interior consists of satin lid pad and high quality handmade insert;
- Available colours: black
- Imprint: company name and logo can be placed on the satin lid pad;
- The series is not produced in Denmark, but purchased in China.

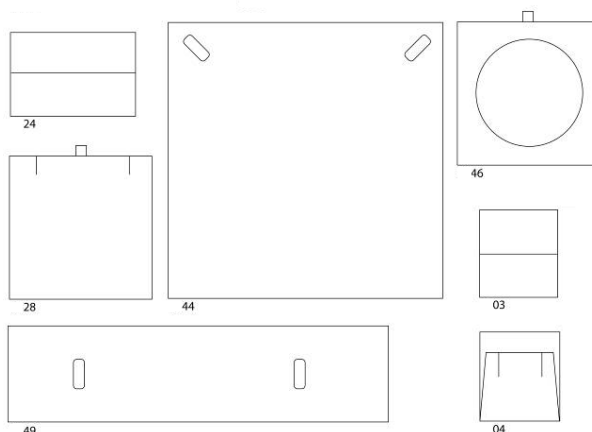

Item no.:	Description:	Size (mm):
3203	Ring	45 x 50 x 37
3204	Earrings	46 x 51 x 31
3224	Wedding rings	72 x 48 x 37
3228	Collier w. pendant	82 x 82 x 27
3244	Collier	158 x 158 x 34
3246	Bracelet w. vacuumed insert	82 x 82 x 27
3249	Bracelet	219 x 55 x 24

Croco – Series 3300

Series of leatherette croco covered jewellery cases



A luxurious line of boxes

Croco is an elegant series which is a perfect packaging solution for luxurious jewellery.

- A confident choice of classic and stylish packaging solution;
- Hinged box, leatherette covered;
- Interior made of satin lid pad and high quality handmade insert;
- Available colours: black
- Imprint: company name and logo can be placed on the satin lid pad;
- The series is not produced in Denmark, but purchased in China.

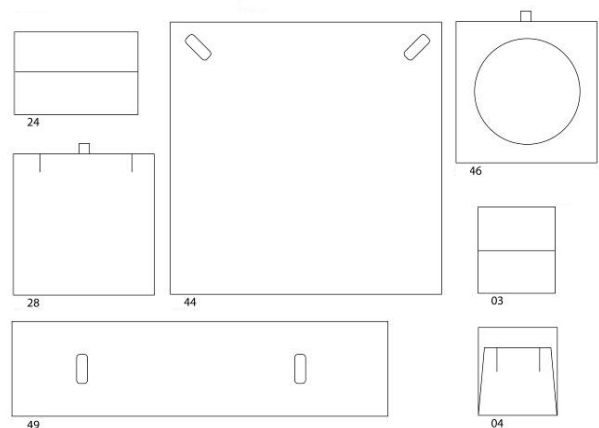

Item no.:	Description:	Size (mm):
3303	Ring	45 x 50 x 37
3304	Earrings	46 x 51 x 31
3324	Engagement rings	72 x 48 x 37
3328	Collier w. pendant	82 x 82 x 27
3344	Collier	158 x 158 x 34
3346	Bracelet/ ring, w. vacuumed insert	82 x 82 x 27
3349	Bracelet	219 x 55 x 24

Quadro – Series 3700



The series emanates elegance and simplicity, which emphasizes the unique of the jewellery.

The closing device of "door to door" combined with silver colored lock gives an interesting way of opening of box.

- The box is covered with matt black paper;
- The bottom is covered with glossy silver
- Insert made of flocked foam in 10 mm.

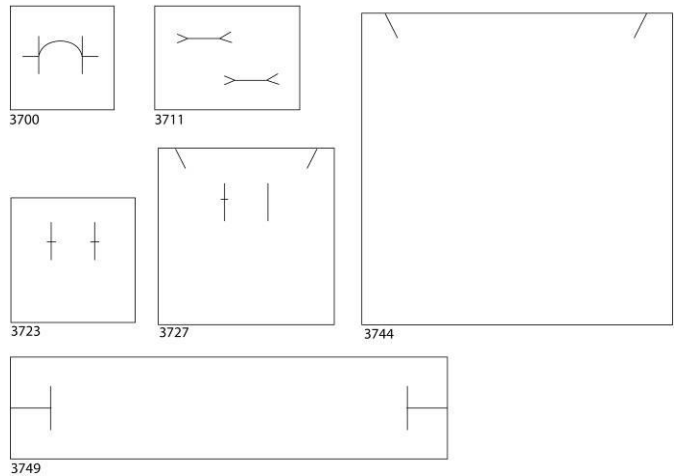

Item no:

3700
3711
3723
3727
3744
3749

Description:

Ring
Wedding rings
Earrings, collier w. pendant
Collier w. pendant
Collier
Bracelet

Size (mm):

50 x 50 x 35
50 x 70 x 35
60 x 60 x 22
85 x 85 x 22
150 x 150 x 25
210 x 45 x 20

Quick Pack – Series 38

For small and quick expedition



Quick Pack is a smart and easy folding box

- Print: golden or silver tampon print. Charge for print € 0, 13/ pcs;
- The box is not produced in Denmark, but purchased in China.

Item no:	Description:
38A	Box, small
38B	Box, large

Size: (mm)
89 x 50
115 x 77

Snow White – Series 3900

Glossy white jewellery boxes



New luxurious series with glossy white surface. The interior made of white velour.

- Imprint: golden or silver on the lid pad.
- The series is not produced in Denmark, but purchased in China.

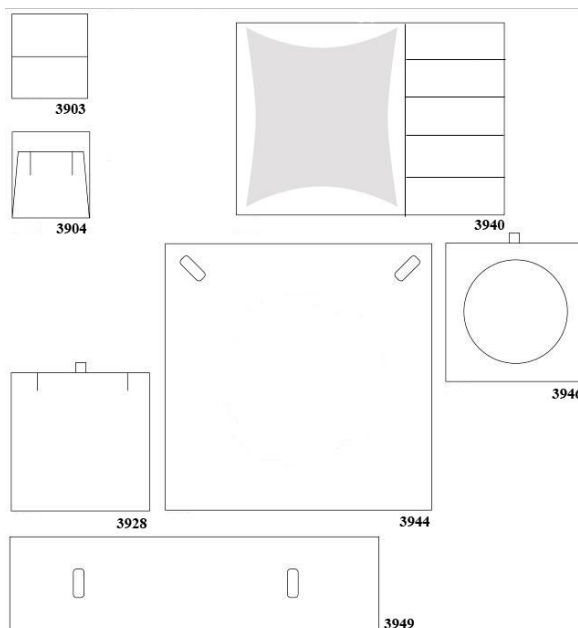

Item no:

3903
3904
3928
3946
3949
3944
3940

Description:

Ring
Earrings
Collier w. pendant
Bracelet/ ring
Bracelet
Collier
Jewellery case

Size: (mm)

45 x 50 x 37
46 x 51 x 31
82 x 82 x 27
82 x 82 x 27
219 x 55 x 24
159 x 158 x 34
146 x 109 x 57

VIP paper bags – Series 3900

Very luxurious paper bags



New luxurious series of paper bags.
Charge for logo imprint € 0, 17/ pcs.

- Imprint: Golden or silver, min. order of 100 assorted bags.



Item no:
3990
3991

Description:
Bag, small
bag, large

Size: (mm)
164 x 115 x 75
216 x 160 x 88

Idol – Series 6100

Wooden box for luxurious jewellery



Exclusive oval wooden box

Lacquered black etui. The etui is delivered with matt black protection cardboard box.

- Insert and lid pad made of leatherette in black;
- Imprint: golden or silver tampon print on the lid pad.

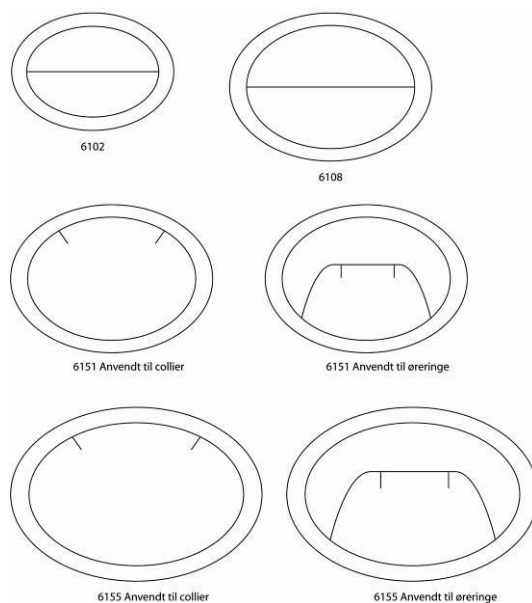

Item no.

6102
6108
6151
6155

Description:

Ring
Wedding rings
Earrings/ Pendant (reversible insert)
Earrings/ pendant (reversible insert)

Size (mm):

69 x 50 x 48
86 x 63 x 53
86 x 63 x 53
107 x 74 x 62

Jarnes A/S	Idol
	Series 6100
January 2011	Price in EUR

Item	Size/ mm	Item no.	5	1
Ring	69x50x48	6102	14,17	21,25
Engagement rings	86x63x53	6108	19,32	28,98
Earrings/ Pendant (reversible insert)	86x63x53	6151	19,32	28,98
Earrings/ Pendant (reversible insert)	107x74x62	6155	21,75	32,63

Insert:	Insert in black matt imitation leather. Lid in black matt imitation leather.	Colour	Outside	Interior
Imprint:	Golden or silver tampon imprint placed on the lid.	1	Black	Black
Price:	Incl. 1 print. Without print 5 % discount.			

EDB: 6102-1 – Ring

Luxurious, oval etui, made of black glossy lacquered wood; incl. beautiful protection cardboard box in black.

OBS: Cliché only with company and city name. Price € 115,-

1 pcs tampon imprint is incl. when buying 20 pcs assorted boxes.
Otherwise charge for start imprinting of € 34, - and logo print € 2, 00,-/ pcs

Push Me

International box concept



New way of thinking about design and function

Unusual and smart box in simple and functional design. We have combined raw cardboard and plastic for an unconventional packaging.

- Lift – off box. The top made of plastic in matt black or silver colour;
- The bottom covered with coated paper in black or silver;
- Imprint: company name and logo can be placed on the top of the box.

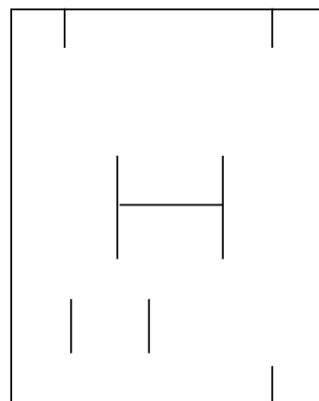

Insert

Jarnes A/S

Push Me

January 2011

Price in EUR

Item	Size/ mm	Qty. pr. outer case	Item no.	3000	1000
------	----------	---------------------	----------	------	------

Box for jewellery set	77x62x25	100	42	1,01	1,10
-----------------------	----------	-----	----	------	------

Imprint:		Colour code	Outside lid and bottom	Interior
	Tampon print on the lid.			
	The lid available in black or silver made of plastic. The bottom made of cardboard, in silver or black. Indlægget er en sort 10 mm skumpude med diverse udstans til smykker.	1-21	Black/silver	Black
		21-1	Silver/ black	Black
Price	Incl. 1 tampon print in black or silver.			

Display for Push Me boxes

Item	Size/mm	Qty.	Item no.	1
PUSH-ME-DISPLAY for 9 boxes Black vacuumed –without logo field	253x286	5	PUSH-ME-DISPLAY-9	33,29
PUSH-ME-DISPLAY for 9 boxes Black vacuumed – logo field upper on top of the display	247x324	5	PUSH-ME-DISPLAY-9-LØ	33,29
PUSH-ME-DISPLAY for 9 boxes Black vacuumed – logo field in the bottom of display	247x324	5	PUSH-ME-DISPLAY-9-LN	33,29

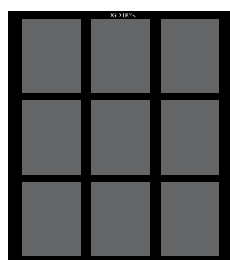

PUSH-ME-DISPLAY-9

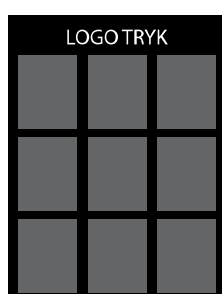

PUSH-ME-DISPLAY-9-LØ



PUSH-ME-DISPLAY-9-LN

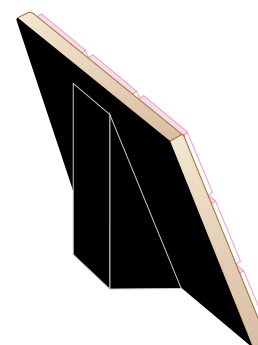

Additional costs, when imprinting logo on displays:

Print start	EUR 47,-
Charge for print	EUR 2,-/pcs
Cliché for tampon print	EUR 115,-
Cliché for hot stamping	EUR 202,-

Organza jewellery bags



Create eye-catching

Put your jewellery in transparent organza bag before they are packed in jewel box. Use the bags outside the box as "the sweet little extra" or exhibit your products, along with the decorative bags.

Just the colour attracts attention and you are happy

Available colours: transparent organza material in black (1), red (8), purple (10).

Delivered without print.



Item no.:	Description:
Org-401	Universal organza bag - small
Org-402	Universal organza bag - medium
Org-601	Universal organza bag – round bottom

Size (mm):
100 x 70
140 x 110
190 x Ø100



Window display

Display with silicone membrane



Smart concept!

Display concept consists of a frame covered with black or white paper and silicone membrane; the display has magnet closing.

Silicone membrane in the window allows displaying different items.

Item no.:

5950-36

5950-02

5950-66

5950-44

Description:

Window, elongated

Window, large

Window, medium

Window, small

Size (mm):

295x90x30

185x185x30

100x100x30

80x80x30

